



EUROPEAN  
COMMISSION

Brussels, 18.1.2018  
SWD(2018) 9 final

**COMMISSION STAFF WORKING DOCUMENT**

**IMPACT ASSESSMENT**

*Accompanying the document*

**Proposal for a Council Directive**

**amending Directive 2006/112/EC on the common system of value added tax as regards  
the special scheme for small enterprises**

{COM(2018) 21 final} - {SWD(2018) 11 final}

## Table of Contents

1.	INTRODUCTION AND CONTEXT .....	11
1.1.	Introduction .....	11
1.2.	Scope and objective of the initiative: a modern, simplified and comprehensive regime for small enterprises .....	12
1.3.	Current framework for SMEs provided for under the VAT Directive .....	14
1.3.1.	Functioning of the common system of value added tax and administrative obligations .....	14
1.3.2.	The notion of an SME under the VAT Directive .....	15
1.3.3.	Rules on taxation of SMEs under the VAT Directive .....	16
1.3.4.	Simplified VAT obligations (outside of the SME scheme).....	17
1.3.5.	Simplified procedures for charging and collecting VAT (part of the SME scheme).....	18
1.3.6.	The SME exemption (part of the SME scheme) .....	18
2.	WHAT IS THE PROBLEM AND WHY IS IT A PROBLEM?.....	20
2.1.	Introduction .....	20
2.2.	The problems .....	21
2.2.1.	Compliance costs: domestic and cross-border .....	21
2.2.2.	Lack of neutrality of the current system.....	24
2.2.3.	VAT revenue losses for Member States .....	25
2.3.	Problem drivers .....	27
2.3.1.	Driver 1 – The complexity of the current VAT rules on obligations .....	27
2.3.2.	Driver 2 – The diversity of the current rules on VAT obligations within the EU.....	29
2.3.3.	Driver 3 – Design of SME exemption .....	30
2.4.	Problem Tree .....	31
2.5.	Evolution of the problem without action at EU level.....	31
3.	WHY SHOULD THE EU ACT? .....	33
4.	WHAT SHOULD BE ACHIEVED? .....	34
4.1.	General objectives .....	34
4.2.	Specific objectives.....	34
4.3.	Consistency of the objectives with other EU policies .....	35
5.	WHAT ARE THE VARIOUS OPTIONS TO ACHIEVE THE OBJECTIVES?.....	35
5.1.	Selection of options .....	35

5.2.	Options analysed .....	36
5.2.1.	<b>Option 1:</b> Status quo, including e-Commerce changes.....	36
5.2.2.	<b>Option 2:</b> SME exemption extended to supplies from other Member States and including streamlined simplified VAT obligations.....	38
5.2.3.	<b>Option 3:</b> Option 2 plus measures to reduce the negative impact of transition from exemption to taxation (the so-called ‘threshold effect’) .....	45
5.2.4.	<b>Option 4:</b> Option 3 plus mandatory common treatment of occasional traders .....	46
5.3.	Discarded options .....	48
5.3.1.	<b>Option 5:</b> Option 2 with full harmonisation of the SME exemption threshold .....	48
5.3.2.	<b>Option 6:</b> Removing the SME exemption from the VAT Directive.	49
5.4.	Key features of the proposed policy options .....	49
6.	WHAT ARE THE IMPACTS OF THE DIFFERENT POLICY OPTIONS AND WHO WILL BE AFFECTED? .....	50
6.1.	Methodology.....	50
6.2.	Analysis of the impacts of each of the options.....	52
6.2.1.	Option 1 – Status quo, including e-Commerce changes.....	52
6.2.2.	Option 2B – SME exemption extended to supplies from other Member States with EU turnover threshold and including streamlined simplification measures .....	55
6.2.3.	Option 3 – Option 2B plus measures to reduce the negative impact of transition from exemption to taxation .....	59
6.2.4.	Option 4 – Option 3 plus mandatory common treatment of occasional traders .....	62
7.	HOW DO THE OPTIONS COMPARE? .....	65
7.1.	Summary assessment of the impacts .....	65
7.2.	Identification of the preferred option .....	67
7.3.	VAT treatment of occasional traders: option not favoured .....	68
7.4.	Subsidiarity of the preferred option.....	69
7.5.	Proportionality of the preferred option.....	69
7.6.	Impact on SMEs .....	69
7.7.	Impact from the REFIT perspective .....	70
8.	HOW WOULD ACTUAL IMPACTS BE MONITORED AND EVALUATED? ..	71
9.	ANNEXES .....	75
ANNEX 1:	PROCEDURAL INFORMATION .....	76

ANNEX 2:	STAKEHOLDER CONSULTATION .....	78
ANNEX 3:	WHO IS AFFECTED BY THE INITIATIVE AND HOW .....	90
ANNEX 4:	ANALYTICAL MODELS USED IN PREPARING THE IMPACT ASSESSMENT .....	92
ANNEX 5:	MEASURES FOR SMES AVAILABLE IN THE VAT DIRECTIVE	102
ANNEX 6:	INTERPLAY AMONG THE LEGISLATIVE PROPOSALS ON THE DESTINATION PRINCIPLE AND ADMINISTRATIVE COOPERATION	108
ANNEX 7:	FUNCTIONING OF OPTION 2 IN AN INTRA-EU CONTEXT .	111
ANNEX 8:	EVALUATION OF THE CURRENT VAT SYSTEM FOR SMES	117
ANNEX 9:	SME EXEMPTION THRESHOLDS IN THE EU (APRIL 2017) .	126
ANNEX 10:	SPECIAL VAT SME MEASURES APPLIED IN MEMBER STATES	128
ANNEX 11:	VAT OBLIGATIONS LINKED TO THE SME EXEMPTION PER MEMBER STATE .....	130
ANNEX 12:	ENTERPRISE EUROPE NETWORK – SME FEEDBACK DATABASE	132

## List of tables

Table 1: Summary of VAT administrative obligations for businesses.....	14
Table 2: Definition of SMEs for VAT purposes (magnitudes in EUR millions).....	15
Table 3: Linking problems to specific objectives.....	34
Table 4: Overview of the key features of different policy options.....	49
Table 5: Summary of methodology used .....	51
Table 6: Simplification scenarios linked to Option 2 and their impact on compliance costs .....	55
Table 7: Summary table of the wider economic impact of Option 2 .....	58
Table 8: Overview of the impacts on compliance costs for businesses under Option 3 .....	59
Table 9: Impact of Option 3 on the wider economy.....	61
Table 10: Businesses' compliance costs under Option 4 .....	62
Table 11: Impacts of Option 4 on the wider economy .....	64
Table 12: Summary analysis of impacts.....	66
Table 13: Monitoring and evaluation framework.....	73
Table 14: Overview of the consultation activities .....	78
Table 15: Overview of the consultation results (by stakeholder category).....	88
Table 16: Impacts on compliance costs under Option 2.....	95
Table 17: Impacts on compliance costs under Option 3.....	96
Table 18: Impacts on compliance costs under Option 4.....	96
Table 19: Impacts on Member States' VAT revenues under Option 2 .....	97
Table 20: Impacts on Member States' VAT revenues under Option 3 .....	98
Table 21: Impacts on Member States' VAT revenues under Option 4 .....	99
Table 22: Interplay among the legislative proposals on the destination principle .....	110
Table 23: Compliance costs for SMEs within and outside the SME exemption in selected Member States.....	121
Table 24: Examples from the SME feedback database .....	132

## **List of figures**

Figure 1: Measures for SMEs available in the VAT Directive .....	17
Figure 2: Key VAT-related barriers to cross-border trade .....	28
Figure 3: Problem Tree.....	31
Figure 4: Functioning of the baseline scenario (including e-Commerce proposal) .....	38
Figure 5: Simplified VAT obligations under Option 2, as compared to the baseline scenario....	44
Figure 6: SME Panel results – most burdensome VAT obligations.....	82
Figure 7: OPC results – distribution of respondents (by category).....	83
Figure 8: OPC results – VAT provisions for SMEs currently applied.....	84
Figure 9: OPC results – weight of VAT obligations in deciding to sell cross-border.....	84
Figure 10: OPC results – opening up of the SME exemption .....	85
Figure 11: OPC results – need to further simplify VAT obligations .....	86
Figure 12: Example of the application of the flat-rate scheme .....	104
Figure 13: Example of the application of the SME exemption.....	106
Figure 14: Example of the functioning of the graduated relief in the Netherlands.....	107
Figure 15: Impact of taxing at destination on the VAT rules for small businesses.....	108
Figure 16: Example Option 2A .....	112
Figure 17: Example Option 2B.....	113
Figure 18: Example Option 2C.....	115

## **List of Boxes**

Box 1: Characteristics of simplified VAT obligations .....	17
Box 2: Characteristics of the simplified procedures for charging and collecting VAT .....	18
Box 3: Characteristics of the SME exemption .....	20
Box 4: Example – VAT burdens faced by an SME wanting to engage in cross-border supplies	23

## List of abbreviations

<b>B2B</b>	Business to Business
<b>B2C</b>	Business to Consumer
<b>CGE</b>	Computable General Equilibrium
<b>CIT</b>	Corporate Income Tax
<b>CJEU</b>	Court of Justice of the European Union
<b>DG AGRI</b>	Directorate-General for Agriculture and Rural Development
<b>DG BUDG</b>	Directorate-General for Budget
<b>DG CONNECT</b>	Directorate-General for Communications Networks, Content and Technology
<b>DG COMP</b>	Directorate-General for Competition
<b>DG ENER</b>	Directorate-General for Energy
<b>DG ENV</b>	Directorate-General for Environment
<b>DG FISMA</b>	Directorate-General for Financial Stability, Financial Services and Capital Markets Union
<b>DG GROW</b>	Directorate-General for Internal Market, Industry, Entrepreneurship and SMEs
<b>DG JUST</b>	Directorate-General for Justice and Consumers
<b>DG TAXUD</b>	Directorate-General for Taxation and Customs Union
<b>EEN</b>	Enterprise Europe Network
<b>EU</b>	European Union
<b>EUR</b>	Euro
<b>GDP</b>	Gross Domestic Product
<b>GFV</b>	Group on the Future of VAT
<b>MOSS</b>	Mini One Stop Shop
<b>OECD</b>	Organisation for Economic Co-operation and Development
<b>OLAF</b>	European Anti-Fraud Office
<b>OPC</b>	Open Public Consultation

<b>OSS</b>	One-Stop Shop
<b>REFIT</b>	Regulatory Fitness and Performance Programme
<b>SCAC</b>	Standing Committee on Administrative Cooperation
<b>SCM</b>	Standard Cost Model
<b>SG</b>	Secretariat-General
<b>SJ</b>	Legal Service
<b>SME</b>	Small and Medium-sized Enterprises
<b>TBE</b>	Telecommunications, Broadcasting and Electronic
<b>TFEU</b>	Treaty on the Functioning of the European Union
<b>VAT</b>	Value Added Tax
<b>VEG</b>	VAT Expert Group

### Glossary

<b>Administrative costs</b>	Costs for tax administrations. Administrative costs for a tax administration will typically include costs relating to the following activities: processing VAT registrations, undertaking VAT audits, reviewing VAT returns, reviewing recapitulative statements, helpline and written query handling and the implementation of new legislation.
<b>Cash-accounting scheme</b>	Measure optional for Member States and businesses, according to which businesses account for the VAT charged (output VAT) only when they have received payment from their customers and deduct VAT paid (input VAT) only once the purchases have been paid to their suppliers. See Annex 5 for more information.
<b>Compliance costs</b>	Costs for businesses. Compliance costs for businesses will typically include costs relating to the following activities: registration for VAT, completion of periodic VAT returns, dealing with a VAT audit, obtaining customer's VAT registration details, completing recapitulative statements and obtaining proof of the intra-EU movement of goods.
<b>Cross-border trade</b>	Refers solely to intra-EU cross-border B2B trade. The terms 'trading across the EU', 'trading cross-border', 'trading in another Member State', 'doing business in other Member States', 'doing business across the EU', 'intra-EU transactions', 'intra-EU trade' refer to any situation where a business: (i) makes supplies of goods taxable in a Member State other than that in which he is established; (ii) acquires goods from a business established in another Member State; or (iii) supplies goods to a customer established in another Member State.
<b>EUROFISC</b>	<a href="#">EUROFISC</a> is a network for the swift exchange of targeted information between Member States.



<b>Fiscalis 2020</b>	<a href="#">Fiscalis 2020</a> is an EU cooperation programme enabling national tax administrations to create and exchange information and expertise.
<b>Flat-rate scheme</b>	Measure optional for Member States and businesses which simplifies the calculation of the VAT due by SMEs. See Annex 5 for more information.
<b>Group on the Future of VAT (GFV)</b>	The <a href="#">Group on the Future of VAT</a> is an informal Commission expert group set up in 2011 in response to the need for a forum where more in-depth discussions on the topics raised in the 2010 Green Paper can be held. The Group is composed of delegates (VAT experts) from the 28 EU Member States' tax administrations and serves as a forum for in-depth discussion and exchange of opinions on the Commission's pre-legislative initiatives and the preparation of future VAT legislation.
<b>Graduated relief</b>	Measure optional for Member States and businesses, according to which the amount of VAT to be collected by a business under the measure is reduced depending on its turnover, with the relief gradually decreasing with the increase of turnover. See Annex 5 for more information.
<b>Input VAT</b>	VAT paid by a business to its suppliers.
<b>Occasional trader</b>	Concept not contained in the VAT Directive, often used for describing private individuals carrying out economic activities on an irregular basis outside of their main employment (i.e. that activity is therefore incidental). For instance, private individuals with photovoltaic installations on their homes producing electricity and selling it to the general network; or also private individuals who on occasion carry out economic activities outside of their main employment, such as selling products online, or sharing goods or services on collaborative economy platforms in exchange for a compensation (e.g. sharing their houses or sharing their cars).
<b>Output VAT</b>	VAT collected by a business from its customers.
<b>Recapitulative statements ('EU Sales Lists')</b>	Declarations submitted by businesses making intra-EU supplies to their tax administrations, usually on a monthly or quarterly basis. In such statements, businesses have to indicate the enterprises in other Member States to whom they have supplied goods. See Annex 5 for more information.
<b>SMEs</b>	At EU level, SMEs are generally defined according to the <a href="#">Commission Recommendation of 6 May 2003</a> concerning the definition of micro, small and medium-sized enterprises. However, for VAT purposes the definition of SMEs is much more restrictive. With its rules for small enterprises, the VAT Directive targets businesses operating on a much smaller scale, which under the general definition would be considered as 'micro-enterprises' (that is, with turnover of up to EUR 2 000 000). Therefore, and also in line with the 2017 Deloitte SME study, for the purposes of this Impact Assessment 'SMEs' (and also the terms 'small enterprises' and 'small businesses') are meant to be: <ul style="list-style-type: none"> <li>• Generally, businesses with turnover of up to <b>EUR 2 000 000</b>.</li> <li>• However, some of the measures in the policy options (e.g. the SME exemption) target an even more restricted sub-set of SMEs. Hence, the analysis sometimes focuses on this specific category, which has been determined to cover businesses below the turnover threshold of <b>EUR 100 000</b>.</li> </ul>
<b>SME exemption</b>	Measure optional for Member States and businesses according to which small enterprises are exempted from collecting and paying VAT, provided that their annual turnover does not exceed a certain threshold. See Annex 5 for more information.

<b>Treasury</b>	A government department related to finance and taxation of a particular jurisdiction (of a Member State or a third country).
<b>VAT accounting ('VAT record keeping' or 'bookkeeping')</b>	VAT obligation for businesses to keep their accounts in sufficient detail for VAT to be collected and declared, and such procedure to be checked by the tax authorities. See Annex 5 for more information.
<b>VAT Committee</b>	Under Article 398 of the VAT Directive, the <a href="#">VAT Committee</a> deals with the obligatory consultations required by certain Articles of that Directive. In addition, it examines questions on the application of the EU VAT provisions raised by the Chairman on his own initiative or at the request of a Member State. The VAT Committee is also a forum for the exchange of views in order to reach guidelines on a uniform application of common practices with regard to VAT provisions.
<b>VAT Directive</b>	Council Directive 2006/112/EC of 28 November 2006 on the common system of value added tax – as amended ( <a href="#">OJ L 347, 11.12.2006, p. 1</a> ).
<b>VAT due</b>	Difference between Output VAT and Input VAT (VAT due = Output VAT – Input VAT).
<b>VAT Expert Group (VEG)</b>	The <a href="#">VAT Expert Group</a> was set up in 2012 by the <a href="#">Commission Decision 2012/C 188/02 of 26 June 2012</a> in response to the request by stakeholders for greater involvement in the process of preparing EU VAT legislation expressed during the public consultation launched by the 2010 Green Paper on the future of VAT. The Group is composed of 40 members: individuals with the requisite expertise in the area of VAT, organisations representing in particular businesses, tax practitioners and academics. The VEG serves as a bilateral forum to allow for an open, structured and transparent dialogue between the Commission and stakeholders on any matter relating to the preparation and implementation of EU legislation and other policy initiatives taken at EU level in the field of VAT.
<b>VAT invoicing</b>	VAT obligation for businesses to issue invoices for every supply made. See Annex 5 for more information.
<b>VAT payment</b>	Obligation to pay the VAT due on a transaction to the tax authorities, which usually lies on the supplier. See Annex 5 for more information.
<b>VAT registration</b>	VAT obligation for businesses to register for VAT purposes when their activity as a business starts, changes or ceases. See Annex 5 for more information.
<b>VAT reporting</b>	VAT obligation for businesses to submit VAT returns and recapitulative statements. See Annex 5 for more information.
<b>VAT return</b>	Declaration made by businesses to their tax administrations where they indicate which are the transactions made, the VAT that they have charged to their customers (output VAT), the VAT that they have paid to their suppliers (input VAT), and the amount of VAT payable or refundable (difference between output VAT and input VAT). See Annex 5 for more information.

## 1. INTRODUCTION AND CONTEXT

### 1.1. Introduction

Value Added Tax (VAT) is a general tax on consumption applied to supplies of goods and services along the whole production and distribution process. It is a major and growing source of tax revenue in the European Union (EU). VAT raised slightly more than EUR 1 trillion in 2015, which corresponds to 7% of EU GDP or 17.6% of total national tax revenues<sup>1</sup>. One of the EU's own resources is also based on VAT (12.4% of the EU budget in 2015)<sup>2</sup>. As a broad-based consumption tax, it is considered to be one of the most growth-friendly forms of taxation.

One of the key strengths of VAT is that, by allowing taxpayers to exactly offset the tax incurred in previous stages of the production chain, it is much better suited than other types of indirect taxes to operate an internal market free of tax distortions. This was the main reason for its early adoption by the EU. It is governed by the [VAT Directive](#)<sup>3</sup> which aims at ensuring that the principles underlying the functioning of this tax apply consistently in all Member States.

In recent years, however, the VAT system has been unable to keep pace with the challenges of the global economy and the opportunities offered by new technologies. Therefore, the Commission adopted on 7 April 2016 an Action Plan on VAT<sup>4</sup> (hereinafter '2016 VAT Action Plan') setting out ways to modernise the VAT system so as to make it simpler, more fraud-proof and business-friendly. In this context, the Commission announced its intention to adopt in 2017 four VAT-related proposals:

- 1) a definitive VAT system for intra-EU cross-border trade based on the principle of taxation in the Member State of destination in order to create a robust single European VAT area (first step);
- 2) a modernised VAT rates policy so as to allow Member States greater autonomy on setting the VAT rates;
- 3) a comprehensive simplification VAT package for SMEs;
- 4) a proposal to enhance VAT administrative cooperation and EUROFISC.

This Impact Assessment relates to the proposal for a comprehensive simplification VAT package for SMEs, which involves a review of the special scheme for small enterprises under the VAT Directive. That is a proposal which is linked in particular to two other legislative initiatives stemming from the VAT Action Plan: (i) the proposal for removing VAT obstacles to cross-border e-Commerce, which was adopted in December 2016 (hereinafter 'e-Commerce proposal')<sup>5</sup>; and (ii) the proposal on a definitive VAT system for intra-EU cross-border trade

---

<sup>1</sup> Eurostat, Tax revenue statistics, [Eurostat \(gov\\_10a\\_taxag\)](http://ec.europa.eu/eurostat/statistics-explained/index.php/Tax_revenue_statistics)  
[http://ec.europa.eu/eurostat/statistics-explained/index.php/Tax\\_revenue\\_statistics](http://ec.europa.eu/eurostat/statistics-explained/index.php/Tax_revenue_statistics).

<sup>2</sup> European Commission, EU Budget 2015, Financial Report  
[http://ec.europa.eu/budget/financialreport/2015/lib/financial\\_report\\_2015\\_en.pdf](http://ec.europa.eu/budget/financialreport/2015/lib/financial_report_2015_en.pdf).

<sup>3</sup> Council Directive 2006/112/EC of 28 November 2006 on the common system of value added tax – as amended (OJ L 347, 11.12.2006, p. 1).

<sup>4</sup> Communication from the Commission to the European Parliament, the Council and the European Economic and Social Committee on an action plan on VAT – Towards a single EU VAT area – Time to decide (COM(2016) 148 final). See also Communication from the Commission to the European Parliament, the Council and the European Economic and Social Committee – On the follow-up to the Action Plan on VAT – Towards a single EU VAT area – Time to act (COM(2017) 566 of 4 October 2017).

<sup>5</sup> Proposal for a Council Directive amending Directive 2006/112/EC and Directive 2009/132/EC as regards certain value added tax obligations for supplies of services and distance sales of goods (COM(2016) 757 final).

foreseen for adoption in September this year (hereinafter ‘definitive VAT system proposal’)<sup>6</sup>. It is also closely related to the VAT place of supply rules for telecommunications, broadcasting and electronically supplied services<sup>7</sup>, which entered into force in 2015 (hereinafter ‘2015 place of supply rules’).

## 1.2. Scope and objective of the initiative: a modern, simplified and comprehensive regime for small enterprises

The scope of the present initiative covers the review of the VAT rules for small enterprises (hereinafter ‘SMEs’) provided for in the VAT Directive, namely: the exemption in the special scheme for small enterprises laid down in Articles 281-294 (hereinafter, the ‘SME scheme’) and other measures outside the scheme which allow to simplify different VAT obligations. The other provisions provided for in the SME scheme, such as other simplified procedures for charging and collecting VAT are not part of this initiative and therefore will not be reviewed in substance.

The small enterprises that will be impacted by the review are those with an annual turnover not exceeding EUR 2 000 000, as in VAT terms only these businesses are generally referred to as SMEs (see section 1.3.2). These small enterprises constitute the vast majority of businesses in the EU (98%).

In addition to the review, this Impact Assessment covers a specific issue relating to the expansion of new opportunities for trade and entrepreneurship resulting from the collaborative economy and digital technologies, which is the VAT treatment of the so-called occasional traders. These traders are private individuals offering services on an occasional basis (e.g. sharing assets or selling electricity home made to the network) which may qualify as taxable person for VAT purposes and consequently benefit from the SME scheme. The increasing number of occasional traders exploiting the opportunities offered by the digital technologies can indeed be a challenge for both Member States and businesses with regard to the application of VAT rules as these traders blur the lines between consumer and supplier, professional and non-professional service provider, private and economic activity. As a result of the assessment, this issue (tackled by the policy option 4 described in section 5.2.4) has not been taken on board in the final SME package, as it would require legislative changes touching upon complex VAT issues that need a distinct evaluation exercise (see section 7.3).

The review is long overdue for several reasons. First of all, despite the fact that the VAT Directive gives Member States the possibility to exempt small enterprises from VAT, a possibility widely used by the Member States, these enterprises as a category continue to suffer from **disproportionate VAT compliance costs** that among others represent a real obstacle to SMEs' growth (see section 2.2.1). It has been assessed indeed that the current SME scheme presents several drawbacks that make the scheme unable to fully address this problem. In

---

<sup>6</sup> Proposal for a Council Directive amending Directive 2006/112/EC on the common system of value added tax as regards certain harmonisation and simplification rules within the current value added tax system and introducing the definitive system for the taxation of trade between Member States, and Proposal for a Council Implementing Regulation amending Implementing Regulation (EU) No 282/2011 as regards certain exemptions for intra-Community transactions, not yet adopted.

<sup>7</sup> For an overview of the 2015 place of supply rules, see [here](#): Council Implementing Regulation (EU) No 1042/2013 of 7 October 2013 amending Implementing Regulation (EU) No 282/2011 as regards the place of supply of services ([OJ L 284, 26.10.2013, p. 1](#)); and Council Regulation (EU) No 967/2012 of 9 October 2012 amending Implementing Regulation (EU) No 282/2011 as regards the special schemes for non-established taxable persons supplying telecommunications services, broadcasting services or electronic services to non-taxable persons ([OJ L 290, 20.10.2012, p. 1](#)).

particular, the SME exemption does not reflect the Single Market perspective and the move to a definitive system based on the destination principle: the scheme is distortive and targeted mostly at businesses trading domestically and in the B2C context<sup>8</sup>.

Moreover, there are two other reasons that call for action. Firstly, the SME scheme is **obsolete** already now, given that it works on the basis of deviations from the general provisions laid down in the VAT Directive<sup>9</sup>. And secondly, the SME scheme, which provides for measures to be applied in the Member State where the small enterprises are established, will become **unsustainable** when the evolution of the VAT system towards taxation at destination is completed. This aspect is further explained in section 2.5.

The goal of the initiative is therefore to set a modern, simplified and comprehensive regime for small enterprises that would allow the achievement of the general objectives: to contribute to the creation of an environment conducive to SMEs' growth, to contribute to the creation of a single EU VAT area and to contribute to the smooth functioning of a deeper and fairer Single Market. The specific objectives are to achieve greater effectiveness in reducing VAT compliance costs for SMEs, more level playing field for them and to contribute to fighting the VAT fraud. The present initiative contributes to the construction of an efficient and robust VAT system based on the destination principle. The general and specific objectives of the initiative are further clarified in section 4.

The proposal draws on the Commission's experience as regards prior initiatives for simplifying VAT rules for small businesses. In this respect, it should be noted that this proposal will not impose harmonised exemption thresholds on Member States (see section 5.2.2). Moreover, the scope of the present initiative is much larger than the previous ones as it covers not only the exemption for small enterprises but also simplified VAT obligations for both exempt and non-exempt businesses. Finally, the initiative encompasses any type of transaction: B2B and B2C supplies of goods and services, in a domestic and cross-border context.

While Member States keep their prudent attitude towards harmonisation of the VAT SME exemption and simplification of obligations, the situation has evolved since the previous proposals were adopted by the Commission in 2004<sup>10</sup> and 2013<sup>11</sup>. In particular, the construction of the Single Market has progressed and the VAT system evolved towards taxation at destination.

The SME initiative is particularly linked with the proposal on the definitive VAT regime because the current provisions of the SME scheme are temporary in character and apply only until the definitive arrangements for B2B cross-border trade enter into force (Article 292 of the VAT Directive). With the new rules, the currently existing exemption for the B2B cross-border supply of goods will disappear and businesses making such supplies will be liable for declaring and paying VAT in the Member State of arrival of the goods. In order to minimise the burden for SMEs making intra-EU transactions in goods, the SME package will allow them to benefit from simplified VAT obligations irrespective of whether they make use of the SME exemption.

It should be noted that the move towards taxation at destination has been pursued in the VAT system already for a while. One such example referred to above are the place of supply rules for

---

<sup>8</sup> The main findings of the evaluation of the current VAT rules for SMEs are presented in Annex 8.

<sup>9</sup> See, for instance, Annex 9 concerning the applicable SME exemption thresholds.

<sup>10</sup> COM(2004) 728 final.

<sup>11</sup> COM(2013) 721 final.

telecommunications, broadcasting and electronically supplied services, which entered into force in 2015, another – the e-Commerce proposal currently under discussion in the Council. It is therefore clear that the present initiative does not necessarily depend on the one on definitive regime and its success in the Council.

The interplay among the different VAT proposals is further explained in Annex 6.

This initiative is part of the Commission’s Regulatory Fitness and Performance Programme<sup>12</sup> (REFIT), which aims to make EU law simple and less costly, in particular for small enterprises.

### 1.3. Current framework for SMEs provided for under the VAT Directive

Some basic explanation of the functioning of the VAT system in general and of the VAT rules for SMEs in particular is provided below in order to set out the context of the review. A more detailed picture is provided in Annex 5.

#### 1.3.1. Functioning of the common system of value added tax and administrative obligations

VAT is a consumption tax, borne ultimately by the final consumer<sup>13</sup>.

Under the EU VAT system, businesses<sup>14</sup> supplying goods or services collect the VAT paid by the consumer, while being able to deduct from the VAT they have collected the amount of tax they have paid to other suppliers on purchases for their business activities. The difference between VAT collected from consumers (output VAT) and VAT paid to other suppliers (input VAT) is the VAT due to the tax authorities.

As a result of businesses having to collect VAT, the VAT Directive lays down a series of administrative obligations<sup>15</sup> which aim at ensuring a correct functioning of the system. These obligations can be summarised as follows:

**Table 1: Summary of VAT administrative obligations for businesses<sup>16</sup>**

VAT obligation	Description
<b>VAT registration</b>	Registration for VAT purposes
<b>VAT invoicing</b>	Issue of invoices
<b>VAT accounting ('record keeping' or 'bookkeeping')</b>	Keeping accounts in sufficient detail for VAT to be applied and its application checked by the tax authorities
<b>VAT reporting (VAT returns)</b>	Preparing and submitting periodical VAT returns and recapitulative statements

<sup>12</sup> For REFIT aspects of this initiative, see Annex 1 to the Communication from the Commission to the European Parliament, the Council, the European Economic and Social Committee and the Committee of the Regions – Commission Work Programme 2017 ([COM\(2016\) 710 final](#)), p. 3. On the REFIT programme itself, see [here](#).

<sup>13</sup> A final consumer means for VAT purposes the last person in a production/distribution chain who is not allowed to deduct the VAT he paid on his purchases (contrary to VAT taxable persons who can do so).

<sup>14</sup> Reference is made to ‘businesses’ (or ‘SMEs’) for simplification reasons throughout this Impact Assessment, but the correct terminology would be ‘taxable persons’. The scope of the concept of ‘taxable person’ can be found in Articles 9 to 13 of the [VAT Directive](#).

<sup>15</sup> For a description of each VAT obligation, see Annex 5.

<sup>16</sup> For further details, see Annex 5.

<b>VAT payment</b>	Collecting the VAT and paying it over to the tax authorities
--------------------	--

Source: Commission services

The compliance burden derived from the need to observe these obligations creates a cost for businesses that is normally referred to as ‘compliance cost’. VAT obligations are particularly burdensome for businesses that are small given that they operate with more limited resources than large enterprises, which leads to small businesses bearing proportionally higher VAT compliance costs than larger businesses<sup>17</sup>. Hence, the VAT Directive sets out several provisions<sup>18</sup> designed to alleviate the burden that small businesses face in dealing with VAT.

### 1.3.2. The notion of an SME under the VAT Directive

At EU level, SMEs are generally defined according to the Commission Recommendation of 6 May 2003 concerning the definition of micro, small and medium-sized enterprises<sup>19</sup> (hereinafter ‘SME definition’). However, for VAT purposes the definition of SMEs is much more restrictive. With its rules for small enterprises, the VAT Directive targets businesses operating on a much smaller scale, which under the general definition would be considered as ‘micro-enterprises’ (see Table 2).

**Therefore, for the purpose of this initiative, SMEs are defined as businesses with annual turnover not exceeding EUR 2 000 000, which according to the EU definition of SME qualify as micro-businesses.** These businesses make up about 98% of all EU enterprises and contribute about 15% of total turnover generated in the EU and about 25% of net VAT revenues<sup>20</sup>. In addition, about 69% of all businesses have a turnover of less than EUR 50 000 and generate 1% of the total turnover in the EU<sup>21</sup>.

The above definition is also consistent with other simplification measures available in the VAT Directive, but outside the SME scheme, which are specific for businesses with turnover below EUR 2 000 000 (e.g. cash accounting).

**Table 2: Definition of SMEs for VAT purposes (magnitudes in EUR millions)**

Commission Recommendation 2003/361				Definition for VAT purposes																	
<ul style="list-style-type: none"> <li><b>SME definition</b> based on the following criteria: <table border="1" data-bbox="268 1373 823 1559"> <thead> <tr> <th>Company category</th> <th>Staff headcount</th> <th colspan="2">Turnover <b>or</b> Balance sheet total</th> </tr> </thead> <tbody> <tr> <td><b>Medium-sized</b></td> <td>&lt; 250</td> <td>≤ € 50 m</td> <td>≤ € 43 m</td> </tr> <tr> <td><b>Small</b></td> <td>&lt; 50</td> <td>≤ € 10 m</td> <td>≤ € 10 m</td> </tr> <tr> <td><b>Micro</b></td> <td>&lt; 10</td> <td>≤ € 2 m</td> <td>≤ € 2 m</td> </tr> </tbody> </table> </li> <li><b>Target:</b> up to EUR 50 m</li> </ul>				Company category	Staff headcount	Turnover <b>or</b> Balance sheet total		<b>Medium-sized</b>	< 250	≤ € 50 m	≤ € 43 m	<b>Small</b>	< 50	≤ € 10 m	≤ € 10 m	<b>Micro</b>	< 10	≤ € 2 m	≤ € 2 m	<ul style="list-style-type: none"> <li><b>No definition as such:</b> reference to ‘small enterprises’ in the VAT Directive</li> <li><b>Target:</b> much smaller businesses (approximately equivalent to the category ‘micro’ according to the Commission Recommendation 2003/361, up to EUR 2 m)</li> <li>Several measure-specific thresholds, the higher of which is EUR 2 m turnover (for cash-accounting<sup>22</sup>)</li> </ul>	
Company category	Staff headcount	Turnover <b>or</b> Balance sheet total																			
<b>Medium-sized</b>	< 250	≤ € 50 m	≤ € 43 m																		
<b>Small</b>	< 50	≤ € 10 m	≤ € 10 m																		
<b>Micro</b>	< 10	≤ € 2 m	≤ € 2 m																		

Source: Commission services

<sup>17</sup> See section 2.2.1.

<sup>18</sup> See sections 1.3.3 to 1.3.5 and Annex 5.

<sup>19</sup> Commission Recommendation of 6 May 2003 concerning the definition of micro, small and medium-sized enterprises (OJ L 124, 20.5.2003, p. 36). See also <http://ec.europa.eu/growth/smes/business-friendly-environment/sme-definition/>.

<sup>20</sup> Deloitte, *Special scheme for small enterprises under the VAT Directive 2006/112/EC – Options for review*, Final Report (hereinafter ‘2017 Deloitte SME study’), Volume I, 2017, p. 27. See also section 2.5.

<sup>21</sup> 2017 Deloitte SME study, Volume I, p. 27.

<sup>22</sup> For information on the cash-accounting scheme, see Annex 5.

### 1.3.3. Rules on taxation of SMEs under the VAT Directive

The measures foreseen in the VAT Directive for small enterprises<sup>23</sup> can broadly speaking be grouped into three categories:

- 1) Simplified VAT obligations
- 2) Simplified procedures for charging and collecting VAT
- 3) SME exemption

These measures are optional for Member States to apply. In addition, small businesses are frequently, but not always, free to choose whether to avail themselves of such measures, as in certain cases an SME may have an economic advantage in using the general rules rather than the SME-specific provisions (e.g. businesses paying a high amount of VAT to other suppliers, which may not be interested in applying the SME exemption, given that it would preclude them from deducting such input VAT<sup>24</sup>).

The majority of such measures aim at reducing compliance costs for businesses (e.g. simplified invoicing, or longer periods for submitting a VAT return), but some are intended to alleviate cash-flow problems by deferring payment of VAT by the business collecting it to the moment that it receives the tax from its client (e.g. cash-accounting<sup>25</sup>), and others release businesses from the obligation to collect VAT altogether (i.e. SME exemption<sup>26</sup>).

Some of those measures, but not all, are part of the SME scheme. Other measures are available for small businesses, however, outside of the SME scheme. As can be seen from Figure 1 below, the fact that all of these measures are scattered throughout the VAT Directive increases the complexity of the current rules. Moreover, they are conceived as measures independent from each other rather than as a full simplification regime for small enterprises, which affects the overall effectiveness of the SME scheme<sup>27</sup>.

---

<sup>23</sup> See Annex 5 for a detailed explanation of such measures.

<sup>24</sup> For information on the SME exemption, see section 1.3.6 and Annex 5.

<sup>25</sup> For information on the cash-accounting scheme, see Annex 5.

<sup>26</sup> For information on the SME exemption, see section 1.3.6 and Annex 5.

<sup>27</sup> Simplified VAT obligations are not part of the SME scheme, but are linked to the use of the SME exemption in particular, which means that small enterprises outside of the SME exemption (e.g. because they exceed the threshold or because they opted out) have no access to such simplification measures.



**Figure 1: Measures for SMEs available in the VAT Directive**

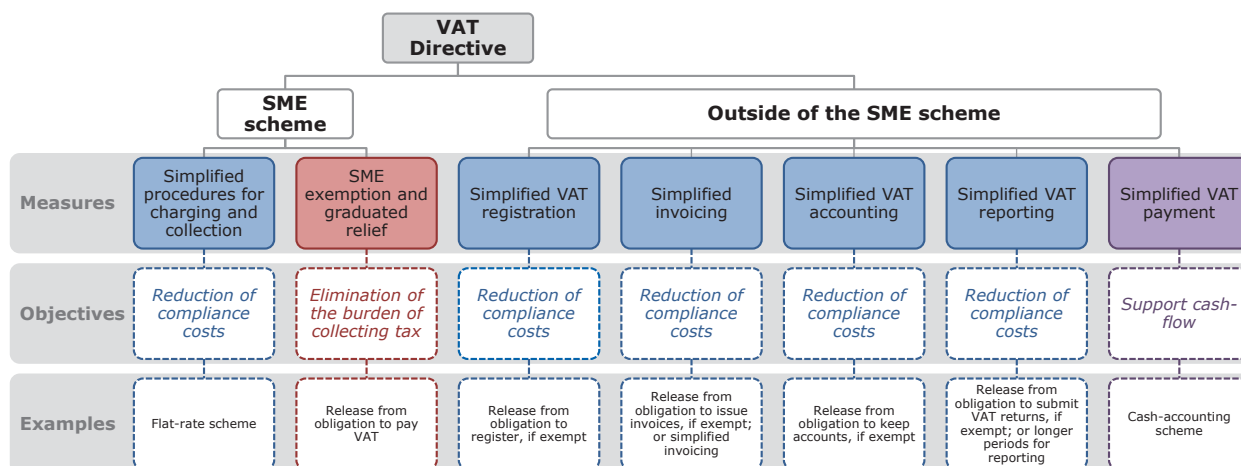

Source: Commission services

### 1.3.4. Simplified VAT obligations (outside of the SME scheme)

Simplified VAT obligations provided for in the VAT Directive<sup>28</sup> are optional for Member States to apply and for businesses to avail themselves of. If available, Member States have considerable flexibility as regards their implementation. As a result of this extensive range of options, the existing simplified VAT obligations and their characteristics vary among Member States, thus increasing complexity for small enterprises operating cross-border.

Simplification measures may therefore concern VAT obligations of a diverse nature, such as the registration of businesses, invoicing, accounting, reporting, and the payment of VAT. Some measures are available to all businesses (e.g. simplified invoicing), and others are specific for small businesses using the SME exemption<sup>29</sup> (e.g. release from certain or all VAT obligations of businesses availing themselves of that exemption). Moreover, the eligibility of businesses to apply the existing simplification measures varies (e.g. some simplification measures are linked to use of the SME exemption; others, such as the cash-accounting scheme, are conditional on business turnover being below certain thresholds). Where simplification measures are linked to use of the SME exemption, small businesses not eligible for exemption or opting not to avail themselves of it cannot benefit from them.

#### Box 1: Characteristics of simplified VAT obligations

- **Optional character:** For both Member States and businesses.
- **Complexity of rules (at domestic level):** Simplified VAT obligations may concern registration, invoicing, accounting ('record keeping'), reporting (e.g. VAT returns), and payment of VAT. These simplification measures are provided for in the VAT Directive outside of the SME scheme, while also being available for small businesses.
- **Different eligibility criteria:** Requirements for businesses to be able to use existing simplification measures may vary (e.g. some are linked to the use of the SME exemption; others, such as the cash-accounting scheme, are nonetheless conditional on the business turnover being below certain thresholds). Where simplification measures are linked to the use of the SME exemption, businesses outside of the exemption cannot benefit from them.

<sup>28</sup> Article 272(1)(d) (all VAT obligations), Articles 220a and 238-240 (VAT invoicing), Article 272(3) (VAT accounting), Articles 252 and 270-271 (VAT reporting), and Articles 66(b) and 167a (VAT payment). For more information, see Annex 5.

<sup>29</sup> Pursuant to Article 272(1)(d) of the VAT Directive.

- **Diversity of rules (at EU level):** Given their optional character, the applicable simplification measures vary across the EU, increasing the compliance costs of small businesses trading cross-border.

Source: Commission services

### 1.3.5. Simplified procedures for charging and collecting VAT (part of the SME scheme)

Member States which might encounter difficulties in applying the normal VAT arrangements to small businesses, by reason of the activities or structure of such enterprises, may set simplified procedures for charging and collecting VAT provided that such measures do not lead to a reduction of the tax due<sup>30</sup>. Such simplified procedures are thus optional for Member States to apply (although they are not widely used, with only 8 Member States having implemented them<sup>31</sup>) and for businesses to avail themselves of. An example of such simplified procedures is the flat-rate schemes<sup>32</sup> used to simplify the calculation and payment of the VAT due by small businesses. Moreover, Member States may be authorised by the Council, acting unanimously on a proposal from the Commission, to introduce special measures for derogation from the provisions of the VAT Directive in order to simplify the procedure for collecting VAT or to prevent certain forms of tax evasion or avoidance, provided that certain conditions are met<sup>33</sup>.

#### Box 2: Characteristics of the simplified procedures for charging and collecting VAT

- **Optional character:** For both Member States and businesses.
- **Different eligibility criteria:** Requirements for businesses to be able to use existing simplified procedure may vary (e.g. some Member States have set a turnover threshold, while others apply the flat-rate scheme on the basis of business sectors).
- **Diversity of rules (at EU level):** The design of flat-rate schemes may vary among Member States having introduced such schemes, with some enabling small businesses to apply a flat-rate to calculate their output VAT and others requiring such businesses to charge VAT on their outputs in accordance with the normal VAT rules whilst allowing a fixed flat-rate sum to be deducted from the amount of VAT due.

Source: Commission services

### 1.3.6. The SME exemption (part of the SME scheme)

The VAT Directive allows Member States to exempt small businesses from VAT provided that their annual turnover does not exceed a certain threshold<sup>34</sup>. The SME exemption is optional for Member States to implement and for eligible businesses to use. This measure has a very high implementation rate among Member States (26 of them have implemented the SME exemption<sup>35</sup>) and also a very high participation rate among eligible businesses (on average 63% across Member States)<sup>36</sup>.

<sup>30</sup> Pursuant to Article 281 of the VAT Directive.

<sup>31</sup> See Annex 10.

<sup>32</sup> For information on flat-rate schemes, see Annex 5.

<sup>33</sup> According to Article 395 of the VAT Directive, the measures intended to simplify the procedure for collecting VAT may not, except to a negligible extent, affect the overall amount of the tax revenue of the Member State collected at the stage of final consumption.

<sup>34</sup> Pursuant to Articles 282-292 of the VAT Directive. For information on the SME exemption, see Annex 5; and for an overview of the thresholds currently applicable in the Member States making use of the SME exemption, see Annex 9 and [here](#).

<sup>35</sup> Sweden is the most recent Member State to have introduced this scheme. For more information, see Annex 10.

<sup>36</sup> 2017 Deloitte SME study, Volume I, p. 42.

This exemption, which for the small businesses eliminates the burden of collecting VAT, is usually accompanied by simplification measures (e.g. release of the obligation to register for VAT purposes, or to indicate VAT on invoices), which lower the compliance burden of businesses concerned.

It is up to Member States, within the limits established by the VAT Directive, to set the thresholds under which the exemption applies. The threshold is an important element in the design of the scheme as it should reflect the trade-off between the need to reduce compliance and administrative costs and the need for Member States to collect VAT revenue. The level at which Member States decide to set the exemption threshold depends on the combination of different economic and policy factors linked to the national context. As a result of this, the level of thresholds varies substantially across the EU. According to information available for 2017<sup>37</sup>, from the Member States making use of the exemption, the lowest threshold is that set by Sweden (EUR 3 168)<sup>38</sup>, while the UK applies the highest one (EUR 97 808)<sup>39</sup>.

The SME exemption is also optional for small businesses to apply. However, small businesses using the exemption cannot deduct their input VAT (i.e. a business cannot deduct the VAT paid in respect of its input supplies from the VAT which the business is liable to pay on the output supplies). Eligible businesses may for instance decide to opt out of the exemption in cases where taxation, which entails deduction of input VAT, is more favourable than being under the exemption without the right to deduct.

The SME exemption is available only to businesses established in the Member State in which VAT is due (i.e. it is not possible to apply the exemption in cross-border trade)<sup>40</sup>. This strict territorial application is not aligned with the ongoing reforms<sup>41</sup> of the VAT system moving towards taxation at destination<sup>42</sup>, according to which many small businesses may have to charge VAT to their customers in Member States other than their own.

The VAT Directive also lays down a variation of the SME exemption, known as graduated relief<sup>43</sup>, which reduces the burden for small businesses of collecting VAT, albeit not completely. A business applying this measure would receive a VAT relief on part of its turnover, which would gradually decrease with the increase of the turnover (the more turnover, the less VAT relief). However, due to high compliance and administrative costs that it induces the graduated relief does not seem to be a particularly effective measure in practice. It is applied by only three Member States (Spain, Finland and the Netherlands), and only 5.7% of the business respondents to the open public consultation recently carried out were using the scheme.

---

<sup>37</sup> See Annex 9.

<sup>38</sup> Original amount of SEK 30 000.

<sup>39</sup> Original amount of GBP 83 000.

<sup>40</sup> See Article 283(1)(c) of the VAT Directive.

<sup>41</sup> Notably, the e-Commerce proposal; and also the ongoing work on the definitive VAT system proposal. For more information on the interaction with the principle of taxation at destination, see Annex 6.

<sup>42</sup> 2016 VAT Action Plan, p. 4.

<sup>43</sup> Pursuant to Articles 282-292 of the VAT Directive. For information on the graduated relief, see Annex 5.

### Box 3: Characteristics of the SME exemption

- **Temporary character of the exemption:** Arrangements regarding exemptions and graduated relief for small businesses apply only until the definitive arrangements enter into force<sup>44</sup>.
- **Optional character:** Both for Member States and businesses.
- **Strict territorial application:** Exemption only covers enterprises established in the Member State in which the VAT is due.
- **Exemption thresholds:** Set out in the VAT Directive or granted by way of derogation. The thresholds currently applied vary greatly and range from slightly above EUR 3 000 to about EUR 100 000 (see Annex 9).
- **Basis** for the calculation of the threshold: **Turnover**, calculated in accordance with the provisions of the VAT Directive.
- Businesses using the scheme may **not indicate VAT on their invoices**.
- Businesses using the scheme **cannot deduct input VAT** paid.

Source: Commission services

## 2. WHAT IS THE PROBLEM AND WHY IS IT A PROBLEM?

### 2.1. Introduction

As set out in the 2011 Communication<sup>45</sup> and the 2016 VAT Action Plan<sup>46</sup>, the EU VAT system is highly complex for businesses generally, and particularly for small enterprises which bear on average proportionally higher VAT compliance costs than large enterprises. In that regard, the Commission receives frequent complaints from business, which confirms the need for action. In addition, the current VAT system does not take into account the Single Market perspective and the evolution towards taxation at destination.

According to the OECD and Eurostat statistics<sup>47</sup>, the SMEs worldwide are most present in the services sector, with smaller firms active particularly in the wholesale and retail trade, horeca sector, communications, business services (e.g. computer software, information processing, marketing, human resource development, etc.) as well as construction and manufacturing, providing a very important source of employment. The sectors they tend to operate in allow their business models to reach cross-border. This, combined with increased outsourcing of specialised services (often provided by SMEs), new technologies and ever growing e-commerce, allows SMEs to break out of their traditional role and seize opportunities offered by the Single Market. However, in doing so, they face numerous problems related to complying with the diverse rules on VAT for small enterprises, which in design were to support them.

The need to act was supported in the open public consultation<sup>48</sup> for this initiative whereby 87% of respondents either agreed or strongly agreed with the objective of the Commission to simplify VAT obligations for small enterprises and 71% supported harmonisation of SME exemptions in the EU. Also enterprises that participated earlier, in the summer of 2016, in the SME panel

<sup>44</sup> In this respect, the definitive VAT system proposal is scheduled for adoption in September this year.

<sup>45</sup> 2011 Communication, p. 5.

<sup>46</sup> 2016 VAT Action Plan, p. 6.

<sup>47</sup> *OECD Policy Brief 'Small and medium-Sizes Enterprises: Local Strength, Global Reach'*, p. 2-3; <http://ec.europa.eu/eurostat/web/structural-business-statistics/structural-business-statistics/sme> as accessed on 17.07.2017.

<sup>48</sup> See Annex 2.

consultation<sup>49</sup> emphasised in their general comments the need for further harmonisation, simplification and clarification of VAT rules across the EU.

## 2.2. The problems

There are in essence **three main problems** with the current VAT rules for SMEs. These problems are inter-related and stem from the complexity of the current system, the lack of alignment between the different SME schemes in place in the 28 Member States, and from the design of the SME exemption. They are further linked to the evolution of the EU VAT regime towards taxation at destination.

The identification of the problems and the problem drivers derive from the 2017 Deloitte SME study and consultations with business and Member States.

### 2.2.1. Compliance costs: domestic and cross-border

This problem is caused by all the three drivers discussed further below in section 2.3: **complexity** and **diversity** of rules on VAT obligations across the EU and **the design of the SME exemption** due to which SMEs trading cross-border cannot benefit from this exemption in Member States others than the one in which they are established.

As pointed out in the 2016 VAT Action Plan<sup>50</sup> and confirmed by the 2017 Deloitte SME study<sup>51</sup>, small enterprises bear **proportionally higher VAT compliance costs than large businesses**. In more general terms, in 2008 it was estimated that where a big company spends EUR 1 per employee because of a regulatory duty, a small business might have to spend on average up to EUR 10<sup>52</sup>.

Compliance costs are **notoriously difficult to measure**. The main methodological challenge in such assessment on the targeted stakeholders is assessing the population that will have to bear the costs and the unit cost. Estimates of VAT-related burdens typically do not include the costs for international activities, let alone to the level of granularity of data distinguishing the smallest of enterprises. While Eurostat provides some data on the incidence of SMEs selling cross-border, for most countries this data does not include the smallest businesses (those with fewer than 10 employees). Moreover, the data available only covers the incidence of cross-border trade; no data is available on the value of sales in each country or the number of firms reaching the VAT registration threshold in each market. Therefore, the effective burden is difficult to pinpoint. **However, the economic literature is unequivocal on the fact that any such costs are heavier for SMEs<sup>53</sup>. SMEs spend on average 2.6% of their sales revenues on tax compliance costs, for large enterprises these costs represent only 0.02% of their sales revenues<sup>54</sup>.**

These costs stem from **the complexity of VAT rules relating to businesses' obligations** – as described in greater detail in section 2.3 – and the extensive and recurrent reporting requirements. In addition, compliance costs are **multiplied for businesses trading cross-border due to the mere need to comply with the different sets of obligations in place in the**

---

<sup>49</sup> *Ibid.*

<sup>50</sup> 2016 VAT Action Plan, p. 6.

<sup>51</sup> 2017 Deloitte SME study, Volume I, p. 22-27.

<sup>52</sup> See also 2008 SBA Communication, p. 7.

<sup>53</sup> See for example [OECD, Taxation of SMEs in OECD and G20 Countries, 2015](#), p. 104.

<sup>54</sup> See [European Commission, European Tax Survey 2004](#), p. 52.

**respective Member States** in which their supplies are taxable. Some of these costs are one-off, fixed setup costs, more or less independent of the size of the company or volume of taxed transactions. They could be seen as an ‘entry fee’ to another market, inhibiting the entry of new companies into cross-border trade. These costs press relatively heavier on small enterprises seeking to make the transition from a business orientated purely to the domestic market to one trading throughout Europe. They could thus distort both the pattern of trade and the size structure of industry by favouring larger firms, for whom the fixed compliance costs and burdens are smaller in proportion of total costs and revenues.

Despite a certain degree of harmonisation as regards obligations, **large differences remain between national systems**. Research shows that on average a firm trading in two Member States would have to deal with **11 differences in VAT-related procedures**<sup>55</sup>. The average cost for SMEs to account for VAT in another Member State is estimated to be **EUR 4 100** annually per Member State they supply to<sup>56</sup>. This discourages SMEs from exploiting the opportunities offered by the Single Market by increasing the costs of border-crossing trade flows relative to domestic sales. Such costs are likely to bear relatively heavily on small and medium-sized businesses which may only be trading small volumes, creating a real market-entry barrier and anti-SME bias in intra-EU trade<sup>57</sup>.

The VAT regulations are complex. Small enterprises may lack the knowledge required to use the correct policies, time schedules and rates for all their transactions. The onus rests on the companies to comply with the VAT rules with financial and even criminal sanctions for failing to do so. On the other hand, companies in their willingness to comply, may register for VAT unnecessarily, potentially due to the apparent uncertainty about international VAT treatment – thereby creating additional administrative costs<sup>58</sup> for tax administrations. Overall, this complexity is such that it forces the majority of small businesses to have **recourse on a permanent basis to costly advisory services**. In reply to the questionnaire published in the framework of an SME panel consultation in spring 2016, over 55% of respondents indicated having used services of an external consultant in the last financial year in order to advise on and help them to comply with their VAT obligations.

Indeed, as demonstrated in **the case study on the cost of compliance for small businesses in Germany under the 2011 IFS retrospective evaluation** of the VAT system study<sup>59</sup>, the proportion of firms which are exporters is very much lower among small firms than among larger firms. Fewer than 5% of firms in the two smallest size classes are engaged in any exporting at all (compared with 11% of firms overall, and more than 40% of firms with an annual turnover in excess of EUR 1 million). The export turnover of the 1.5 million German firms in the two smallest size classes is of almost trivial economic significance, less than EUR 650 million (less than 1/10 of 1% of all firms’ exports). Nevertheless, those small firms

---

<sup>55</sup> Institute for Fiscal Studies (IFS) and others, *A retrospective evaluation of elements of the EU VAT system*, 2011 (hereinafter ‘2011 IFS retrospective evaluation of the VAT system study’), available [here](#). The study refers in this context to two EU15 Member States. By contrast, the countries that joined the EU in the major enlargement in 2004 have fewer administrative differences in their VAT regimes than the EU15 countries. A possible reason is that these countries were able to start a VAT system from scratch and have chosen to adapt best-practice procedures from the EU15 countries.

<sup>56</sup> Deloitte Study for the Commission on ‘Modernising VAT for cross-border e-Commerce’ – Lot 1, p. 45. This study refers to the notion of an SME in the sense of the general definition as set out in Recommendation 2003/361.

<sup>57</sup> 2011 IFS retrospective evaluation of the VAT system study, p. 22.

<sup>58</sup> 2017 Deloitte SME study, Volume I, p. 47.

<sup>59</sup> 2011 IFS retrospective evaluation of the VAT system study, p. 78-79.

that do participate in exporting have quite substantial levels of exports in relation to their turnover – more than 20% of turnover in the lowest two size classes, a higher percentage than in medium-sized firms, and broadly equal to the export share for exporting firms as a whole. Although by no means a conclusive demonstration, this pattern of exporting behaviour strongly suggests that small firms encounter ‘**fixed entry cost**’ barriers to exporting that are **proportionately more significant** than for larger firms.

Some similar concerns that engaging in international trade is a major source of complexity for small enterprises were raised as well by the **UK’s Office of Tax Simplification**<sup>60</sup> during their investigation of the scope for further simplification of taxes for small businesses. It concluded that although international trade is dominated by large firms, it does not indicate that the small business problem is unimportant: most trade could be conducted by large firms precisely because small firms are deterred, which (if true) would indicate that the problem is severe<sup>61</sup>.

While it is difficult to be precise about the costs and burdens, to appreciate better the difficulties faced by the small enterprises an anecdotal example<sup>62</sup> as put forward in the 2011 IFS retrospective evaluation of the VAT system study<sup>63</sup> may come useful.

#### **Box 4: Example – VAT burdens faced by an SME wanting to engage in cross-border supplies**

Consider a small business in a provincial town, which one day receives a phone call from a firm in another EU Member State who wishes to place an order. The trader is delighted to receive the call, but is immediately apprehensive about accepting the order. First of all, she does not know which tax regime would apply to the supply. Would it be taxed in her country or in her customer’s country? Would she have to register for VAT in the destination country, and would that depend on whether sales to customers in that country alone exceeded that country’s registration threshold? If the destination country’s VAT regime is relevant at all, what VAT rate applies to her products in that country? What paperwork would she have to complete, and would her record-keeping have to change from what she already did for domestic VAT purposes?

Not only does our would-be exporter not know the answers to these questions (and many more); her regular tax advisor – a high street accountant accustomed to dealing only with domestic tax – does not know either. Moreover, neither of them knows quite where to find out. Their domestic tax authority does not consider it their concern; the tax authority in the foreign country may have a website, but they do not know where to find the relevant information, and indeed the website or paper literature may be in a language they do not understand (even a different alphabet). The best way to find out the VAT implications of accepting this order may well be to approach a firm of tax advisors with greater specialist knowledge, but this is likely to be expensive.

All of this is before the would-be exporter has even found out what the VAT implications of accepting this order would be, let alone actually incurred any actual additional costs of selling her products abroad. Even before considering the costs of actually complying, the costs of merely ascertaining her obligations must be considered.

And at the time she receives the phone call, she may have little idea what the costs (in time and money) of finding out the VAT implications of this sale would be. The sheer uncertainty might be enough to dissuade her from accepting the order, to choose to ‘play safe’.

Much of the costs described above relate to the category of costs that can be called as the ‘hassle’ costs. They are even more difficult to quantify/monetize or relate to specific obligation. They are the costs felt by the businesses and relate to situations of administrative delays, cumbersome access to information, familiarisation time, the opportunity cost of waiting time, sorting out cases of inconsistencies between received information or instructions, lengthy litigations, etc. Whereas unquantifiable, one can assume that these costs, exacerbated in the cross-border situations by other factors such as geo-blocking or simply language-related difficulties, when falling on the shoulders of fewer staff in the smallest enterprises, are felt hardest.

Source: 2011 IFS retrospective evaluation of the VAT system study

<sup>60</sup> An independent office of HM Treasury giving independent advice to the government on simplifying the UK tax system: <https://www.gov.uk/government/organisations/office-of-tax-simplification/about> .

<sup>61</sup> 2011 IFS retrospective evaluation of the VAT system study, p. 78-79.

<sup>62</sup> See Annex 12 for other examples, obtained from the Enterprise Europe Network.

<sup>63</sup> *Ibid.*, p. 77-78.

### 2.2.2. *Lack of neutrality of the current system*

The problem described in this section stems mainly from drivers linked respectively to the **design of the SME exemption** and to **diversity of rules on VAT obligations**.

Strict territorial limitation of the VAT exemption provided for under the SME scheme, leaving only small enterprises established within the Member State of taxation to benefit, raises serious issues. It has a **negative impact on the competitive situation of suppliers established in other Member States compared to that of domestic suppliers of goods and services**.

The issues are set to increase with the shift towards taxation at destination. One such example is linked to the rules by which telecommunications, broadcasting and electronically supplied services provided to final consumers have been taxed at destination since 1 January 2015. These rules imply that small enterprises having had no VAT obligations in their own Member State (because they were able to make use of the SME exemption) now have to charge VAT in the Member State of their customer without having access to the exemption from which their competitors established in that Member State can benefit.

**This means that there is no level playing field for small enterprises to trade within the European Union.** Some respite is given by the common EU threshold introduced by the e-Commerce proposal (see section 5.2.1) but it is not sufficient to alleviate the distortive effects. UEAPME, the European SME umbrella organisation, representing about 12 million enterprises<sup>64</sup>, in its position paper on the SME scheme, published in June 2017, confirms the distortive effects of the current VAT rules on competition and calls for a more level playing field for SMEs in order to encourage them to fully seize the potential of the Single Market<sup>65</sup>.

The competitive disadvantage vis-à-vis domestic suppliers contributes further to discouraging SMEs from carrying out cross-border operations and in consequence prevents broader exploitation of the opportunities that the Single Market should bring. These problems were signalled already in reaction to the 2010 Green Paper on the future of VAT<sup>66</sup> (hereinafter ‘2010 Green Paper’). That Paper was followed by a six-month public consultation on how the EU VAT system could be strengthened and improved to the benefit of all stakeholders. The Commission received 1 726 replies from businesses, academics, citizens and tax authorities, which constituted a record response to a tax consultation at the time. As regards the SME scheme under the VAT Directive, these respondents pointed, indeed, to the distortion of competition created by the territorial application of the SME exemption.

Also more recent data stemming from the 2017 Deloitte SME study support the above claims. It shows that while on average 30% of enterprises make supplies to other Member States, among the smallest enterprises (with turnover of less than EUR 50 000) only around 12% sell to other Member States<sup>67</sup>.

45% of respondents to the recent public consultation, closed on 20 March 2017, indicated interest in benefitting from the SME exemption in other Member States. 50% of respondents

---

<sup>64</sup> See UEAPME’s website at <http://www.ueapme.com/>.

<sup>65</sup> UEAPME, Position Paper, UEAPME’s policy recommendations for a Special Scheme for Small Enterprises under the VAT Directive, 29.06.2017, p. 2-3:  
[http://www.ueapme.com/IMG/pdf/UEAPME\\_position\\_paper\\_on\\_VAT\\_SME\\_Scheme.pdf](http://www.ueapme.com/IMG/pdf/UEAPME_position_paper_on_VAT_SME_Scheme.pdf).

<sup>66</sup> Green Paper on the future of VAT – Towards a simpler, more robust and efficient VAT system (COM(2010) 695 final).

<sup>67</sup> 2017 Deloitte SME study, Volume I, p. 45.



found that businesses from other Member States should be able to benefit from the SME exemption provided for in their own Member State. As the most important potential benefits of the opening of the SME exemption to suppliers from other Member States, 43% of the respondents indicated that it would primarily make it easier to carry out supplies in other Member States and 39% stated that it would primarily encourage start-ups and SMEs to grow quicker and that it would help to achieve a more level playing field for companies.

In addition to the cross-border dimension, lack of neutrality of the SME exemption also affects **competition on domestic markets – that is between suppliers benefitting from the exemption and suppliers not able to benefit from it** despite having similar turnover; because they have exceeded the threshold or they have opted for the application of the normal VAT rules. Such a distortive effect is inherent in any threshold and is not limited to the SME exemption. In addition to distortive impact on competition, the existence of the threshold means also that SMEs due to the fear of going above the threshold may limit their turnover which would impede growth. This is supported by the analysis of ‘bunching’ behaviour of businesses below the threshold, i.e. high concentration of enterprises immediately below the threshold<sup>68</sup>, limiting the growth of taxed sales, for example, by redirecting production to less taxed goods or services or by scaling down investment and marketing, in order to prevent taxation. The firms could also be artificially split when the turnover seems to exceed the threshold giving the retailer below the threshold an unfair competitive advantage over taxed retailers<sup>69</sup>. On the basis of the existing evidence, it is difficult to assess the magnitude of the problem. Feedback provided by stakeholders suggests that **the ‘threshold effect’** of the exemption may indeed prevent SMEs from growing, but is not conclusive<sup>70</sup>. Nevertheless, addressing some of the disincentives inherent to the ‘threshold effect’ should contribute to securing more level playing field for the EU’s SMEs.

Another feature of a non-neutral EU VAT system is linked to **the high level of divergence between the different national rules on VAT obligations** – as described further in section 2.3.2 – which creates a fixed-cost trade barrier, because of the costs that the companies would need to bear in adapting to VAT regimes of other Member States. Such fixed-cost trade barriers could have a negative impact even on the intent to participate in cross-border trade, particularly for small enterprises. On a global scale such divergence inhibits the completion of the Single Market, effectively distorting the competitive conditions for its enterprises.

### 2.2.3. VAT revenue losses for Member States

The problem described in this section stems from **all the three drivers** set out in section 2.3.

More precisely, challenges for Member States and tax administrations in terms of VAT losses are derived both from the VAT foregone from the SME exemption and non-compliance stemming from the complexity of VAT rules and differences between rules applicable in the respective Member States.

---

<sup>68</sup> 2017 Deloitte SME study, Volume I, p. 121-122.

<sup>69</sup> 2011 IFS retrospective evaluation of the VAT system study, p. 85.

<sup>70</sup> The threshold effect of the exemption was spontaneously invoked in replies to the 2010 public consultation on the 2010 Green Paper. More recently though, in the public consultation closed on 20 March 2017, only 7% of respondents indicated that they limit the growth of their sales in order to keep turnover levels below the exemption threshold.

Firstly, as regards the **VAT foregone**, the 2017 Deloitte SME study estimates the gross VAT revenue that exempt businesses would generate at EUR 13.4 billion or 1.3% of net VAT revenues. However, accounting for the fact that businesses would then be able to deduct their input VAT, the actual net VAT revenue at stake is estimated at EUR 3.8 billion, or 0.4% of net VAT revenues collected in the EU<sup>71</sup>. It should be noted that it is Member States' choice to forgo the VAT that would have been collected from the small enterprises. The main reason behind it is the socio-economic motives linked to the creation of growth friendly conditions for small enterprises. Moreover, the negligible contribution of the small enterprises to the overall VAT revenues is often outweighed by the enforcement costs that the authorities would need to bear to monitor SMEs' compliance with their VAT obligations. The present initiative aims nevertheless at ensuring that within the current framework, the Member States can exert the desired level of control and ensure that VAT is duly paid and no VAT is unduly refunded.

Secondly, regarding **non-compliance of businesses with VAT rules**, it is important to note that part of it is not necessarily due to fraudulent intentions on the side of entrepreneurs, but to complexity of VAT rules for SMEs. As pointed out in the 2017 Deloitte SME study<sup>72</sup>, while SMEs already find it difficult to comply with domestic VAT obligations, compliance with cross-border obligations is an even more serious obstacle. Lack of alignment among Member States' rules on VAT obligations for SMEs together with the domestic nature of SME schemes may create problems for businesses which start trading cross-border or have incidental cross-border supplies (taxable in another Member State). One simple example (referred by some of the businesses interviewed for the study) is where an SME supplier is benefitting from the SME exemption and is also relieved from VAT obligations on his domestic supplies. Such SMEs will not easily understand the consequences of starting trading in another Member State (e.g. that it is required to register for VAT and cannot benefit from the SME exemption in the other Member State or apply the domestic scheme to all its cross-border supplies). It should be noted that the situation should, to a certain limited extent, improve already with the introduction of the Common EU threshold set out in the e-Commerce proposal. It is, however, up to the initiative subject to this Impact Assessment to propose a more systemic solution.

While the 2017 Deloitte SME study confirms broadly concerns regarding non-compliance and fraud linked to SME exemption, it provides no quantitative data. Neither are these available in the existing VAT gap calculations<sup>73</sup>.

**Legitimate claims of input VAT may also cause problems.** This is, in particular, the case of the so-called **occasional traders** whose treatment is currently not harmonised across the EU and puts in doubt the fairness of taxation while reducing potentially revenues due from VAT. The notion of an occasional trader would need to be further defined for the purposes of the review. In the current Impact Assessment it is used to denote individual users of the collaborative economy platforms<sup>74</sup> and individuals whose incidental activities may qualify as an economic activity<sup>75</sup>. While having a very limited taxable turnover and, consequently, output VAT, occasional traders

---

<sup>71</sup> 2017 Deloitte SME study, Volume I, p. 123.

<sup>72</sup> 2017 Deloitte SME study, Volume I, p. 114 and the following.

<sup>73</sup> 2017 Deloitte SME study, Volume I, p. 123.

<sup>74</sup> See VAT Committee Working Paper No 878, VAT treatment of sharing economy, taxud.c.1(2015)4370160-EN, Brussels, 22 September 2015 and the Guidelines, taxud.c.1(2016)1162824-EN, Brussels, 1 March 2016, both available at [https://ec.europa.eu/taxation\\_customs/business/vat/vat-committee\\_en](https://ec.europa.eu/taxation_customs/business/vat/vat-committee_en).

<sup>75</sup> See e.g. Court of Justice of the European Union (CJEU), judgment of 20 June 2013, *Finanzamt Freistadt Rohrbach Urfahr*, C-219/12, ECLI:EU:C:2013:413, on the basis of which individuals using photovoltaic installations qualify as economic operators.

may have paid important input VAT which may result in disproportionate deductions. These losses are currently of limited magnitude, but the situation is bound to evolve in the future as a result of developments relating to new forms of economic activity and technological development that ultimately blur the lines between consumers and businesses, that is, private and economic activity. The 2017 Deloitte SME study estimated the number of occasional traders at 6.4 million businesses and individuals, or 15% of all EU enterprises<sup>76</sup>. The VAT treatment of an increasing number of occasional traders poses significant challenges for Member States' tax administrations, since compliance control costs are disproportionate compared to revenue collected.

Finally, the **complexity** of the VAT rules for SMEs alone can also have a noticeable cost to the Member States' economic performance and, by extension, the tax revenues. In fact, the 2011 IFS retrospective evaluation of the VAT system study<sup>77</sup> estimated that a 10% reduction in differences in VAT procedures could boost intra-EU trade by up to 3.7% and the GDP by up to 0.4%.

In addition, compliance is difficult to monitor due to the large number of small businesses making use of the SME exemption and due to the simplification measures attached to this exemption. As businesses benefitting from the SME exemption generally do not submit VAT returns, it is reportedly challenging for tax authorities to check whether their turnover is below the SME exemption threshold<sup>78</sup>.

### 2.3. Problem drivers

The problems indicated above are caused by a set of interlinked drivers. It is not really possible to attribute a single driver to every problem. It is rather so that the combination of the drivers causes a series of problems. For example, high compliance costs for SMEs are driven not only by complexity of VAT rules, but for cross-border trading companies they result also from the diversity of rules across the EU and from the design of the SME exemption which makes it impossible for them to benefit from that exemption in other Member States.

#### 2.3.1. Driver 1 – The complexity of the current VAT rules on obligations

The evidence collected through stakeholder consultations, external studies and in-house research clearly shows that the rules on VAT obligations are **complicated, non-harmonised, costly for business and difficult for Member States when it comes to ensuring compliance**.

Already the 2010 Green Paper emphasised compliance burdens on businesses stemming from the complexity of the VAT rules<sup>79</sup>. It pointed out that dealing with VAT accounted for almost 60% of the total burden measured for 13 priority areas identified under the Better Regulation Agenda. Particular areas of concern included key elements in the system such as obligations, deduction and rates. These can be particularly severe for SMEs which cannot always afford tax expertise to deal with increasingly complex VAT rules.

---

<sup>76</sup> 2017 Deloitte SME study, Volume I, p. 177.

<sup>77</sup> 2011 IFS retrospective evaluation of the VAT system study, p. 15.

<sup>78</sup> 2017 Deloitte SME study, Volume I, p. 164.

<sup>79</sup> 2010 Green Paper, p. 4.

In this context it is telling that, according to an ongoing study, despite the fact that the average compliance cost is lower for VAT than for Corporate Income Tax (CIT), on average, enterprises find VAT compliance to be more irritating than CIT compliance<sup>80</sup>.

In the context of the 2015/2016 Deloitte e-Commerce study<sup>81</sup>, a mix of 25 businesses across 8 Member States were interviewed with the view to rank four VAT-related barriers to cross-border trade: (1) varying distance sales thresholds, (2) monitoring of distance sales thresholds, (3) distortion of competition, and (4) dealing with different tax legislation and procedures in different countries. As shown in Figure 2, the need to deal with complex legislation and administrative procedures in different countries was found most burdensome irrespective of the size of the enterprises. The most burdensome procedures were identified to be the VAT registration and VAT declaration/refund. The interviewed companies highlighted the need to resort to external advisors to deal with national authorities of other Member States, which led to additional cost incurred.

**Figure 2: Key VAT-related barriers to cross-border trade**

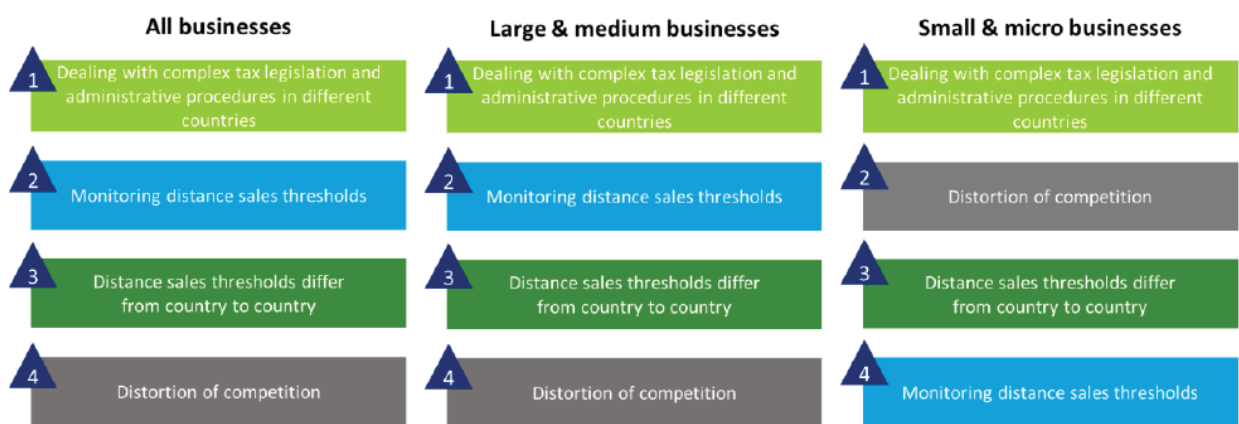

Source: 2015/2016 Deloitte e-Commerce study

As mentioned above, in sections 2.1 and 2.2, in spring 2016 the Commission launched an SME panel consultation<sup>82</sup> with a view to reaching out to SMEs in order to obtain their input. The Commission received more than 1 700 replies to the survey, which constitute an important contribution to the works on the SME reform package. The replies gathered through the consultation help to understand the experience of SMEs with VAT obligations and the compliance burden that these entail as well as SMEs' views on the most needed simplification measures. Of the replies received over 70% came from enterprises with a stated turnover of up to EUR 2 000 000, i.e. microenterprises in the sense of the general SME definition<sup>83</sup>. One-third of all respondents were enterprises with a stated turnover not exceeding EUR 100 000, which were the ones possibly most concerned with the issues linked to the SME exemption.

Almost one-third of the respondents considered complexity of VAT legislation as the main problem in ensuring compliance with VAT obligations. As the most problematic VAT obligations almost 15% of respondents indicate filing VAT returns and over 12% deadlines for VAT payments.

<sup>80</sup> KPMG, Study on tax compliance costs for SMEs, Draft Second Interim Report, 12.4.2017, p. 37.

<sup>81</sup> Deloitte Study for the Commission on 'Modernising VAT for cross-border e-Commerce' – Lot 1.

<sup>82</sup> See section 2.2 of Annex 2 for details.

<sup>83</sup> See table 2.

In their spontaneous, general comments enterprises that participated in the survey emphasised the need for further harmonisation, simplification and clarification of VAT rules across the EU. In particular, several respondents referred to the need for simplification of requirements regarding record keeping, invoicing and reporting.

Also in the most recent open public consultation<sup>84</sup>, closed in March 2017, 87% of respondents either agreed or strongly agreed that VAT obligations on SMEs should be further simplified.

### 2.3.2. Driver 2 – The diversity of the current rules on VAT obligations within the EU

Currently Member States apply **different simplified procedures for charging and collecting VAT and a number of simplification measures aimed at reducing the compliance burden on SMEs**. While all these measures are designed to simplify the obligations on SMEs, the mere existence of different sets of obligations in the respective Member States causes additional costs to small enterprises trading cross-border. The 2011 IFS retrospective evaluation of the VAT system study<sup>85</sup> provided a unique matrix of VAT dissimilarity indices for every bilateral country pair in the EU, which aggregated 116 various – qualitative and quantitative – aspects and functional domains in national VAT regimes, including rate structures, heterogeneity of administrative procedures, and the compliance cost burdens created by national VAT regimes. They capture the degree to which two EU Member States differ in their policies or practices and demonstrate that, as already mentioned before, a firm trading in two Member States would have to deal on average with 11 differences out of the 30 general VAT-related procedures<sup>86</sup>. This result was found statistically significant and having an impact on the levels of cross-border trade.

Indeed, the VAT Directive leaves considerable flexibility to Member States as regards measures aimed at simplifying VAT obligations on SMEs. This means that, despite coordination at the EU level on the basic structure of the VAT system, the situation is still such that companies operating in the Single Market have to deal with a complex and heterogeneous web of different national VAT rules.

The 2017 Deloitte SME study<sup>87</sup> illustrates well the diversity of national rules on obligations which virtually form a patchwork of schemes applicable to small enterprises in the EU. An overview of the special VAT measures for SMEs applied in all 28 Member States is included in Annex 10. A table showing the diversity of obligations linked to the SME exemptions in place in the EU Member States is provided in Annex 11.

Also in the before mentioned most recent open public consultation<sup>88</sup>, 80% of respondents either agreed or strongly agreed that simplified VAT obligations on SMEs should be harmonised. This claim is supported as well by UEAPME in its Position Paper referred to above in section 2.2.2<sup>89</sup>.

However, it must be pointed out that despite a clear case for harmonisation of VAT obligations for small enterprises, the Commission while preparing a proposal in this respect must be mindful

---

<sup>84</sup> See section 2.3 of Annex 2.

<sup>85</sup> 2011 IFS retrospective evaluation of the VAT system study, Chapter 5.

<sup>86</sup> 2011 IFS retrospective evaluation of the VAT system study, p. 22. The main procedures included in the methodology to calculate the indicator on general administrative procedures related to VAT included VAT registration thresholds, VAT refunding thresholds, issuing and storage of invoices, filing and payment deadlines, penalties, etc.

<sup>87</sup> 2017 Deloitte SME study, Volume I, p. 28 and the following.

<sup>88</sup> See Annex 2.

<sup>89</sup> See [http://www.ueapme.com/IMG/pdf/UEAPME\\_position\\_paper\\_on\\_VAT\\_SME\\_Scheme.pdf](http://www.ueapme.com/IMG/pdf/UEAPME_position_paper_on_VAT_SME_Scheme.pdf).

of its past experience, in particular two proposals regarding respectively [the simplified VAT obligations](#)<sup>90</sup> and [a standard VAT return](#)<sup>91</sup> in which simplification and harmonisation of the VAT obligations was put forward. Both proposals had to be withdrawn due to a lack of consensus in the Council.

### 2.3.3. Driver 3 – Design of SME exemption

Another driver of the problems with the current SME schemes across the EU is linked to **the way the exemption is constructed**. The 2017 Deloitte SME study found that the SME schemes at national level meet their principal objective to reduce SMEs' compliance costs<sup>92</sup>. However, this assessment concerns only the small enterprises in their domestic situation whereas all of those benefits are neutralised the moment the company decides to trade cross-border and bear the costs of complying with the VAT regime of another Member State.

The problems with the overall effectiveness of the SME scheme as seen from the perspective of the Single Market are linked to several factors.

First of all, the SME exemption is characterised by the limitation of the **territorial application of the scheme** to small enterprises established in the Member State in which the VAT is due, which has a distortive impact on competition between domestic suppliers and suppliers from other Member States and renders the exemption incompatible with the evolution of the VAT system towards taxation at destination and a genuinely single VAT area. This feature of the current exemption schemes is moreover difficult to reconcile with the basic principles of the Single Market.

Secondly, there are **broad differences between national exemption thresholds** (see Annex 9) **and between simplification measures linked to the exemption in different Member States**.

Thirdly, optionality of the exemption for enterprises can result in **disproportionate input VAT claims** by the so-called 'occasional traders' opting for application of normal VAT rules, which means that they have the right to deduction of their input VAT<sup>93</sup>, which in turn results in revenue losses for Member States.

Finally, the **lack of any transitional period to facilitate the transition from exemption to taxation** may have an effect of discouraging small enterprises from growing. This would be due to the fact that exceeding the turnover threshold, even if temporarily, would deprive them of the possibility to benefit from the exemption, as mentioned above. They would thus be falling from a situation of being fully exempt and having lighter obligations into a situation of having to comply with a full set of VAT obligations in addition to supporting the burden of collecting VAT. This effect has been subject to a study by the existing literature<sup>94</sup>. According to some authors, data suggest that as small firms grow and approach the SME exemption threshold, a non-trivial proportion of them slow down their growth to avoid crossing the threshold and

---

<sup>90</sup> Proposal for a Council Directive amending Directive 77/388/EEC with a view to simplifying value added tax obligations ([COM\(2004\) 728 final](#)).

<sup>91</sup> Proposal for a Council Directive amending Directive 2006/112/EC on the common system of value added tax as regards a standard VAT return ([COM\(2013\) 721 final](#)).

<sup>92</sup> 2017 Deloitte SME study, Volume I, p. 47-53.

<sup>93</sup> See e.g. [Finanzamt Freistadt Rohrbach Urfahr](#), on the basis of which individuals using photovoltaic installations qualify as economic operators and therefore as VAT taxable persons. Similar problems may relate also to the users of collaborative economy platforms.

<sup>94</sup> L. Liu and B. Lockwood B., 'Efficiency and welfare costs of VAT: Evidence from VAT notches', 2015, p. 26.

having to register for VAT purposes. In such circumstances, the saving in tax and compliance costs exceeds the reduction in sales volume<sup>95</sup>. Such an effect of the design of the SME exemption threshold clearly runs counter to the Commission’s objective of removing the barriers for start-ups scaling up into bigger firms as proclaimed in the 2016 Start-Up Communication<sup>96</sup>.

## 2.4. Problem Tree

A summary of the problems, the problem drivers and the effects is presented below.

**Figure 3: Problem Tree**

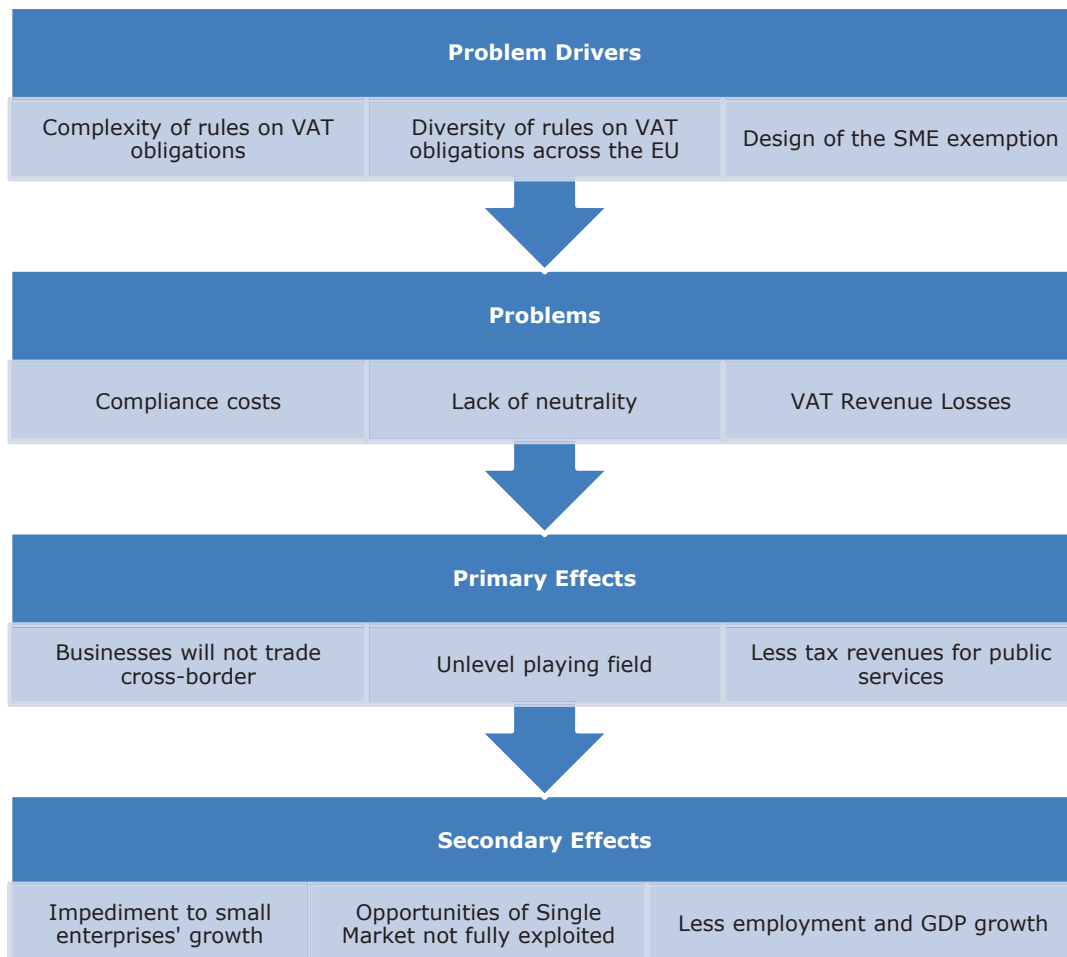

Source: Commission services

## 2.5. Evolution of the problem without action at EU level

SMEs with turnover of up to EUR 2 000 000 constitute about 98% of all EU enterprises and contribute about 15% of total turnover generated in the EU and about 25% of net VAT revenues. The smallest businesses, those with less than EUR 50 000 of turnover represent about 69% of all businesses and generate only about 1% of the EU-wide turnover, with a negligible or negative amount of net VAT revenues<sup>97</sup>. All these SMEs face disproportionate VAT compliance costs

<sup>95</sup> *Ibid.*, p. 26.

<sup>96</sup> [COM\(2016\) 733 final](#)

<sup>97</sup> See 2017 Deloitte SME study, Volume I, p. 27.

compared to larger enterprises and as a result their performance and growth is impaired across the EU and their entry into the Single Market is discouraged.

The **problems** identified in section 2.2, particularly the lack of a level playing field for businesses and revenue losses for Member States, **will only increase** if there is no action at EU level. Furthermore, the high compliance costs for businesses wishing to trade cross-border will continue, in the absence of simplification, to hold back the development of the Single Market.

In addition, it must be noted that already today the provisions of the VAT Directive as regards taxation of SMEs require a serious update. The basic threshold for SME exemption set out in Article 284 amounts to EUR 5 000 of annual turnover<sup>98</sup>. Today only one Member State<sup>99</sup> out of 26 applying the exemption sets its threshold at a lower level and nine<sup>100</sup> Member States set their exemption thresholds on the basis of derogations from the VAT Directive's provisions<sup>101</sup>.

Moreover, as the VAT system gradually evolves towards taxation at destination, the current provisions of the VAT Directive on taxation of SMEs and, in particular, on the SME exemption, **will become completely out of date**. Strict territorial limitation of the VAT exemption provided for under the SME scheme, leaving only small enterprises established within the Member State of taxation to benefit and for their domestic supplies only, was established when the vision of the EU VAT system was still based on the principle of origin. It will not work in a system based on taxation at destination. In such a system VAT has to be declared and accounted for in the Member State where the customer is established (Member State of 'destination'), rather than in the Member State where the SME making the supply is established (Member State of 'origin'). The principle of taxation at destination is being mainly implemented by a set of three complementary legislative initiatives: (i) the 2015 place of supply rules, which entered into force in 2015; (ii) the e-Commerce proposal, adopted in 2016; and (iii) the definitive VAT system proposal, to be adopted in 2017<sup>102</sup>. While some of these initiatives foresee measures to smooth the effects of SMEs having to declare and pay VAT in the Member State of destination, further support is needed<sup>103</sup>.

The above changes mean that in practice a small enterprise established in one Member State and selling to customers in all other Member States will have to declare and pay VAT in 27 different Member States from the very first supply (because no SME exemption is available in the Member State of destination); and also observe 27 different sets of VAT rules (e.g. as regards registration, or other VAT obligations)<sup>104</sup>. This scenario is distortive for small enterprises selling cross-border vis-à-vis those selling only domestically and also hampers SMEs' growth and discourages them from fully seizing the opportunities of the Single Market. Some of the

---

<sup>98</sup> This basic level of threshold was set in 1977 and has not since been changed.

<sup>99</sup> Sweden which only recently took up this option.

<sup>100</sup> Belgium, Croatia, Italy, Latvia, Lithuania, Luxembourg, Poland, Romania, and Slovenia.

<sup>101</sup> For an overview of the thresholds currently applicable in the Member States making use of the SME exemption, see Annex 9.

<sup>102</sup> For more explanation on the interplay among the legislative proposals on the destination principle, see Annex 6.

<sup>103</sup> For more information about how the VAT package for SMEs will complement these proposals, see Annex 6.

<sup>104</sup> Businesses may already have had to declare and pay VAT in the Member State where the customer is located in some circumstances, according to the existing place of supply rules. For instance, pursuant to Article 44 of the VAT Directive, the place of supply of services to a taxable person acting as such, i.e. Business to Business (B2B) is the place where that person has established his business. In contrast, Business to Consumer (B2C) supplies of services are taxed where the supplier is established pursuant to Article 45 of the VAT Directive, which may change after the implementation of the destination principle.



contributions received through the REFIT platform referred to this problem (see Annex 2). In particular, submission XVIII.3.a by the Danish Business Forum, which stressed the complexity of the VAT legislation that businesses operating at EU level must face, which goes against the Single Market: *‘In the Internal Market it should in principle be just as easy to do business with a customer in Poland and Germany as with a customer in Denmark. However, because VAT rules are not harmonised the consequence is that companies that begin to trade within the internal market often encounter difficulties’.*

Having said the above, it should be noted that the first step in order to address this problem, for a limited proportion of supplies, has been made in the e-Commerce proposal through the common EU threshold below which B2C sales of goods and services in other Member States can be treated as domestic transactions. It is up to the present initiative to develop a more systemic solution.

### **3. WHY SHOULD THE EU ACT?**

SMEs are the backbone of the European economy but still in all phases of their lifecycle they face obstacles which preclude them from seizing the full potential of the Single Market. The complexity of the EU VAT system can result in a high compliance burden on SMEs, particularly when trading with other Member States. This does not only hamper their growth but may even prevent them from engaging in cross-border trade and reap the benefits of the Single Market. Despite representing a significant part of the economic activity in the EU, small businesses only generate 15% of the total EU turnover compared to large companies which contribute the rest 75%.

The main problems which have been identified (distortive effects, high compliance costs, etc.) are triggered by the rules of the VAT Directive as they stand. In particular, the current VAT rules for small businesses suffer from several drawbacks: the rules do not reflect the Single Market perspective and the move to a definitive system based on the destination principle: the special scheme for businesses is targeted mostly at businesses trading domestically and in the B2C context.

Given that VAT is an EU tax, Member States are currently not allowed to set different rules themselves and therefore any initiative to modernise VAT obligations and the SME exemption requires a proposal by the Commission to amend the VAT Directive.

The legal basis is Article 113 of the TFEU which states that

‘The Council shall, acting unanimously in accordance with a special legislative procedure and after consulting the European Parliament and the Economic and Social Committee, adopt provisions for the harmonisation of legislation concerning turnover taxes, excise duties and other forms of indirect taxation to the extent that such harmonisation is necessary to ensure the establishment and the functioning of the internal market and to avoid distortion of competition’.

Therefore, it is necessary for the Commission, which has responsibility for ensuring the smooth functioning of the Internal Market and promoting the general interest of the European Union, to propose action to improve the situation.

This initiative is in line with the commitments made by the Commission to address several key difficulties faced by SMEs<sup>105</sup>. In particular, in its 2015 Single Market Communication a set of actions were proposed in order to remove economically significant barriers that hold back Europe’s jobs, growth and investment agenda. Moreover, in the 2016 VAT Action Plan<sup>106</sup>, the Commission took further commitment to prepare a simplification package for SMEs, as also reflected in the 2016 Start-Up Communication<sup>107</sup>.

#### 4. WHAT SHOULD BE ACHIEVED?

##### 4.1. General objectives

The **general objectives** of this initiative are:

- 1) to contribute to the creation of an **environment that is conducive to SMEs’ growth**<sup>108</sup>;
- 2) to contribute to the creation of an efficient and robust VAT system with a view to creating a **single EU VAT area**<sup>109</sup>; and
- 3) to contribute to the smooth functioning of a **deeper and fairer Single Market**<sup>110</sup>.

##### 4.2. Specific objectives

The specific objectives of this initiative are identified below, together with how they link to the problems.

**Table 3: Linking problems to specific objectives**

Problem	Specific objectives
1) Compliance costs	1) To reduce VAT compliance costs for SMEs at two levels, domestically and within the EU: <ul style="list-style-type: none"> <li>• Compliance costs for domestic small businesses, derived from complex national VAT rules.</li> <li>• Compliance costs for small businesses trading cross-border, derived from the diversity of VAT rules across the EU.</li> </ul>
2) Lack of neutrality	2) To reduce distortions at two levels, domestically and within the EU (more level playing field for SMEs): <ul style="list-style-type: none"> <li>• Distortions between small businesses under the SME exemption and the small businesses that do not make use of the exemption.</li> <li>• Distortions between domestic suppliers and suppliers established in other Member States.</li> </ul> 3) To reduce the negative impact of the threshold effect (small firms slowing

<sup>105</sup> Communication from the Commission to the European Parliament, the Council, the European Economic and Social Committee and the Committee of the Regions upgrading the Single Market: more opportunities for people and business ([COM\(2015\) 550 final](#)), p. 4.

<sup>106</sup> 2016 VAT Action Plan, p. 6.

<sup>107</sup> Communication from the Commission to the European Parliament, the Council, the European Economic and Social Committee and the Committee of the Regions – Europe’s Next Leaders: The Start-Up and Scale-Up Initiative ([COM\(2016\) 733 final](#)), p. 4.

<sup>108</sup> 2016 VAT Action Plan, p. 6.

<sup>109</sup> *Ibid.*, p. 9.

<sup>110</sup> *Ibid.*, p. 6; and the 2015 Single Market Communication, p. 4.

	down their growth to avoid crossing the SME exemption threshold) – seen also in the context of providing a more level playing field.
3) VAT revenue losses for Member States	4) To facilitate compliance by SMEs and monitoring by tax administrations. 5) To reduce revenue losses caused by occasional traders. Both of the above objectives should be seen in the context of fighting the VAT fraud.

Source: Commission services

### 4.3. Consistency of the objectives with other EU policies

The initiative is consistent with the creation of a simple, modern and fraud-proof VAT system which is one of the fiscal priorities set out by the Commission for 2017 (Annual Growth Survey 2017<sup>111</sup>).

Moreover, the proposed initiative and its objectives are consistent with the specific policy of the EU as regards SMEs. In this respect, the need to reduce VAT compliance costs derived from the complexity of the rules for SMEs provided for in the VAT Directive, and thus ease compliance by SMEs and monitoring by tax administrations, is set out in the 2008 SBA Communication<sup>112</sup>, the 2011 Communication<sup>113</sup>, and the 2016 VAT Action Plan<sup>114</sup>. The Commission has also committed to reduce distortions derived from the design of the current rules and to help SMEs to fully benefit from the potential of the Single Market in the 2008 SBA Communication<sup>115</sup>, the 2015 Single Market Communication<sup>116</sup>, the 2016 VAT Action Plan<sup>117</sup>, and the 2016 Start-Up Communication<sup>118</sup>.

The objectives of this initiative are also consistent with the EU objectives under the REFIT programme to make EU law simple and less costly, in particular for small enterprises. They do not have an impact on fundamental rights.

## 5. WHAT ARE THE VARIOUS OPTIONS TO ACHIEVE THE OBJECTIVES?

### 5.1. Selection of options

Based on the problem assessment and policy objectives, four policy options have been identified as follows:

**Option 1:** *Status quo, including e-Commerce changes (baseline scenario)*

**Option 2:** *SME exemption extended to supplies from other Member States and including streamlined simplified VAT obligations*

<sup>111</sup> Communication from the Commission to the European Parliament, the Council, the European Central Bank, the European Economic and Social Committee, the Committee of the Regions and the European Investment Bank – Annual Growth Survey 2017 ([COM\(2016\) 725 final](#)), p. 13.

<sup>112</sup> 2008 SBA Communication, p. 4-5 and 7-8.

<sup>113</sup> 2011 Communication, p. 7.

<sup>114</sup> 2016 VAT Action Plan, p. 6.

<sup>115</sup> 2008 SBA Communication, p. 4-5 and 12-14.

<sup>116</sup> 2015 Single Market Communication, p. 4.

<sup>117</sup> 2016 VAT Action Plan, p. 6.

<sup>118</sup> 2016 Start-Up Communication, p. 4.

**Option 3:** *Option 2 plus measures to reduce the negative impact of transition from exemption to taxation*

**Option 4:** *Option 3 plus mandatory common treatment of occasional traders*

These options, which were already laid down in the Inception Impact Assessment<sup>119</sup>, have been analysed in the 2017 Deloitte SME study and tested with businesses and Member States at a Fiscalis 2020 Workshop in Wrocław in March 2017.

The options are targeted at reducing VAT compliance costs for SMEs, reducing the distortive effects of the exemption and the complex and diverse rules on VAT obligations for SMEs and at contributing to the creation of an environment that is conducive to the SMEs' growth. The policy options also take into account the Member States' perspective, and in particular the need to minimise the risks of abuse and to facilitate the monitoring by tax administrations.

The main focus of the policy options is on simplifying VAT obligations for SMEs and reviewing the SME exemption. The need for simplified VAT obligations has been pointed out by SMEs as one of the key elements of the review during the consultation process<sup>120</sup>; while the SME exemption as such remains a key element of the current rules, as further explained in section 5.3.2.

The policy options are built on each other in a gradual manner so that the subsequent options add new elements to the ones included in the previous options. Option 4 represents therefore a full package of measures. This approach should allow a comprehensive assessment of the cumulative cost and benefit effect of each policy option and their comparative analysis.

In addition to the options proposed for further analysis and impact assessment two discarded options are set out. Their inclusion allows a better understanding of the context of the initiative and of the way in which the options subject to impact assessment are shaped.

## **5.2. Options analysed**

### **5.2.1. Option 1: Status quo, including e-Commerce changes**

This option serves as the benchmark against which the other options are assessed (baseline), and has the characteristics of the current system:

- SME exemption optional for both Member States and businesses.
- SME exemption limited to domestic businesses making domestic supplies only.
- National SME exemption thresholds, generally based on the total turnover derived from domestic supplies.
- Exempt SMEs not able to indicate VAT on their invoices or deduct their input VAT.
- Possible simplified VAT obligations for businesses benefitting from the SME exemption.
- Taxation in the Member State of destination of B2C supplies of telecommunications, broadcasting and electronically supplied services (2015 place of supply rules).

---

<sup>119</sup> [Inception impact assessment](#) on the review of the special scheme for small enterprises under the VAT Directive 2006/112/EC.

<sup>120</sup> See sections 2.3.1 and 2.3.2, and Annex 2.

In addition, this policy option contains the elements included in the e-Commerce proposal<sup>121</sup>, notably:

- Removal of the intra-EU distance selling threshold for B2C supplies of goods.
- Extension of the existing MOSS to intra-EU distance sales of tangible goods and to services other than electronic services as well as to distance sales of goods from third countries – MOSS becomes a One-Stop Shop (OSS). As a result of this, in general all cross-border B2C supplies of goods and services, as well as imports, will be charged in the Member State of the final consumer.
- Introduction of a common EU threshold of EUR 10 000 (hereinafter, ‘common EU threshold’), optional for businesses, below which B2C sales of goods and services in other Member States can be treated as domestic transactions. Note that this threshold refers to the place of supply but it is not an exemption, unlike the SME exemption threshold. It is calculated on the basis of the turnover derived from all B2C cross-border supplies<sup>122</sup> made by businesses to other Member States, and does not take into account domestic supplies.

#### How will the common EU threshold interact with the SME exemption?

The introduction of the common EU threshold will relieve SMEs, particularly micro businesses with low value cross-border B2C supplies, from having to comply with the full set of VAT obligations in each Member State of destination.

Although the SME exemption threshold can be applicable to both B2C and B2B transactions<sup>123</sup>, the common EU threshold of EUR 10 000 only covers B2C supplies.

An EU business making B2C supplies in other Member States (which should be taxed in the Member State of destination) may with the common EU threshold opt to treat these supplies as domestic transactions if its annual turnover generated from such supplies does not exceed EUR 10 000. That business could apply the SME exemption in its own Member State, if available, as long as the overall domestic turnover of the business (that is, domestic supplies plus deemed domestic supplies) remains below the SME exemption threshold. Once the common EU threshold is exceeded, the supplier will have to register, declare and account for VAT in the Member States where its customers are established but can do so through the extended OSS (goods and services). That business may decide not to make use of the common EU threshold and declare VAT in the Member State of destination straight away, in which case it will also be able to register and declare VAT through the extended OSS.

Figure 4 below illustrates how the common EU threshold interacts with the SME exemption in the baseline scenario.

---

<sup>121</sup> The e-Commerce proposal envisages the introduction of the reforms proposed in two phases: 2018 and 2021. For the purposes of this Impact Assessment, the full package of changes proposed to be implemented by 2021 has been included in the baseline scenario.

<sup>122</sup> For more information, see Article 59c of the [e-Commerce proposal](#).

<sup>123</sup> See Article 283 of the VAT Directive.

**Figure 4: Functioning of the baseline scenario (including e-Commerce proposal)**

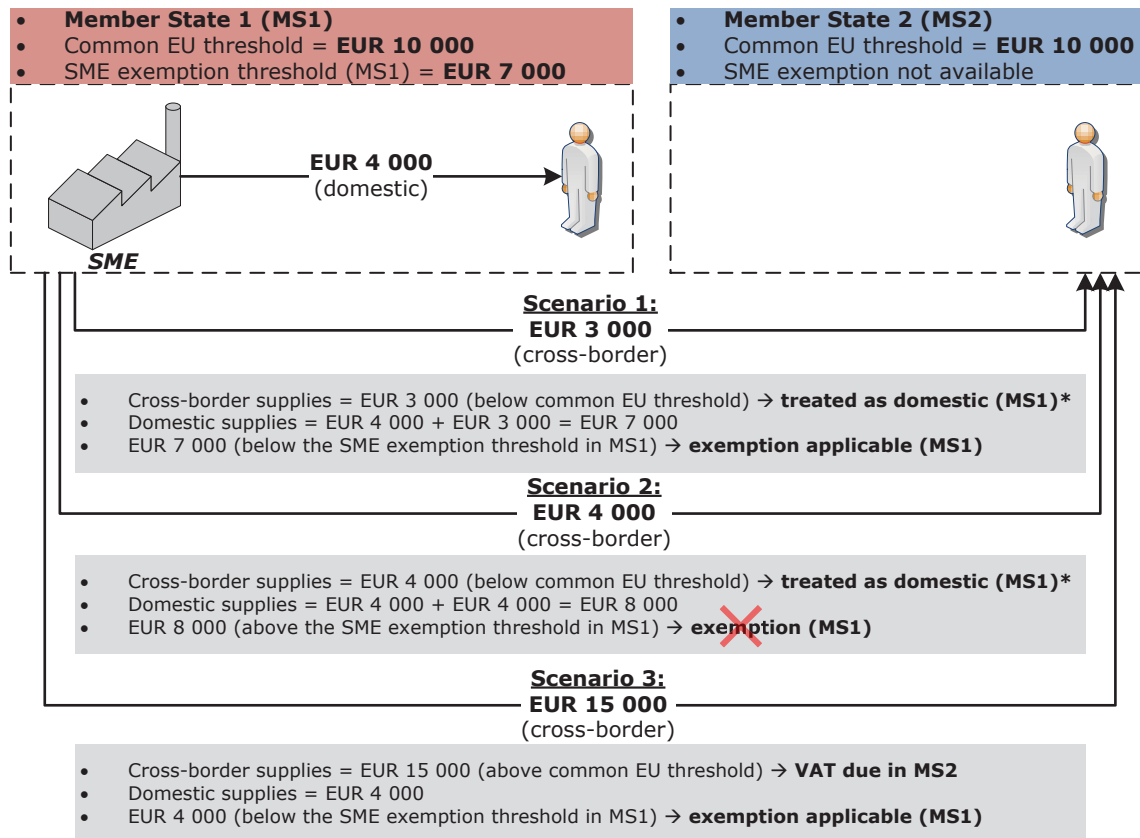

\* It is assumed that the SME decides to make use of the common EU threshold (voluntary)

Source: Commission services

### 5.2.2. *Option 2: SME exemption extended to supplies from other Member States and including streamlined simplified VAT obligations*

This option introduces two significant changes to the current rules for SMEs:

- The SME exemption would be opened to all eligible SMEs within the EU, and
- The simplified VAT obligations would be available to an enlarged category of small businesses, irrespective of whether they use the exemption:
  - Small enterprises with turnover below the SME exemption threshold:
    - Exempt
    - Non-exempt (opting for the application of normal VAT rules)
  - Small enterprises with turnover above the SME exemption threshold and up to EUR [2 000 000]<sup>124</sup> – non-exempt.

#### SME exemption adjusted to a VAT system based on the destination principle

Under current rules, SMEs can only benefit from the SME exemption in the Member State where they are established. This restrictive territorial application of the exemption creates

<sup>124</sup> The EUR 2 000 000 as the turnover threshold to qualify as a small enterprise eligible for the application of the simplified VAT obligations is tentatively proposed in the present initiative – for more explanations – see below, p. 43.

unequal treatment of SMEs (the benefit of the scheme depends on whether the business is established) and, in particular, discourages SMEs from engaging in cross-border activities and fully seizing the opportunities of the Single Market. This option addresses these issues by opening the national SME exemption available in a Member State to supplies made by businesses established in other Member States, in line with the principle of taxation at destination. The opening up of the exemption received much support from businesses, business associations and Member States during the consultation process, while ensuring that the system is not prone to abuse.

The SME exemption in the Member State of destination (where the VAT is due) would be applicable to eligible businesses having to declare VAT in that Member State (e.g. because their cross-border supplies exceed the common EU threshold, or because they have decided to opt out of that threshold). A non-established business from another Member State would be eligible for applying the SME exemption in the Member State of destination where VAT rules will apply.

Therefore, SMEs engaged in B2C intra-EU trade<sup>125</sup> will have different alternatives as regards the VAT treatment of their sales to other Member States:

- Use the common EU threshold and treat cross-border supplies as domestic, which could then benefit from the SME exemption in their own Member State.
- If the common EU threshold is exceeded (or not used), and VAT has to be declared in the Member State of destination, use the SME exemption in the Member State of destination, if available and business eligible.
- If the common EU threshold is exceeded (or not used), and VAT has to be declared in the Member State of destination, register and pay VAT in the Member State of destination and benefit, if eligible, from simplified VAT obligations in place in that Member State.
- If the common EU threshold is exceeded (or not used), and VAT has to be declared in the Member State of destination, declare and pay VAT in the Member State of destination on B2C sales via the extended One Stop Shop (OSS).

### SME exemption threshold

Another element is the threshold below which businesses can apply the SME exemption. Under this option, it could be desirable, in terms of simplification for businesses, to fully harmonise the exemption threshold at EU level. However, imposing the same threshold on all Member States (notwithstanding the political challenge that such a choice implies) would have different impact on Member States' revenues and domestic markets that not necessarily would bring a better result in terms of cost efficiency and level playing field. Indeed, it should be noted that the optimal level of the threshold varies among Member States as it depends on the combination of different economic and policy factors. Additionally, the optimal level of the threshold should reflect the trade-off between the need to reduce compliance and administrative costs and the

---

<sup>125</sup> For the purposes of this analysis, it is assumed that businesses engaged in B2B intra-EU trade would continue to apply the reverse charge mechanism at least until the adoption of the definitive regime. Under a reverse charge (Articles 194 to 199b of the VAT Directive), the liability to pay the VAT collected to the Treasury is generally moved from the supplier of a good or a service to the customer. Therefore, such businesses will not be affected by the extension of the SME exemption as they do not have VAT obligations in the Member State of destination (as regards invoice and VAT return obligations, the rules of the Member State of establishment apply). However, these businesses will still be able to benefit from the SME exemption in their own Member State if they so wish.

need for Member States to collect VAT revenue<sup>126</sup>. For that, the option to introduce a standard EU threshold was discarded (see section 5.3.1). Thus, it was considered more appropriate to provide Member States flexibility to tailor the scheme to the characteristics of their domestic markets and policy environment; in particular, it was decided to allow Member State to set their national thresholds.

### Safeguards

Although the aim is to ensure equal treatment of domestic businesses selling in a Member State and non-established businesses selling in that same Member State, we cannot exclude that opening up the SME exemption as described above could create some new distortions. In fact, if the only criterion that matters for applying the SME exemption in a Member State would be the turnover generated by a business in that Member State, then non-established EU businesses trading cross-border could benefit from the SME exemption more extensively than businesses trading domestically only. During the stakeholder consultation, business associations and Member States in particular highlighted the need to limit to some extent the opening up of the SME exemption in order to avoid possible abuse.

Two types of potential adverse distortions have been identified.

Firstly, it could be that large companies not qualifying as small businesses for the purposes of this Impact Assessment end up benefiting from this option. For instance, let us imagine a large company with an EU turnover of EUR 10 million with a very low amount of B2C intra-EU sales in a Member State where it is not established. If the SME exemption in that Member State is available for non-established EU businesses based on the turnover generated there, that company could be eligible for applying the exemption in that Member State (and in all other Member States where it is not established and the exemption is available).

Secondly, even if a business qualified as a small business for the purposes of this Impact Assessment, it would still be possible for that business to cumulatively benefit from the SME exemption in each of the Member States where the exemption is available, provided that the turnover generated in each of those Member States was below their respective SME exemption thresholds.

Hence, some safeguards could be introduced in order to prevent such distortions:

- Putting in place an overall **EU turnover threshold**, in order to limit the size of businesses that can benefit from the SME exemption in different Member States, and thus ensure that this option is SME-targeted.
- Leaving Member States the possibility to **limit the application of the SME exemption** by non-established SMEs. This could involve, for instance, setting a lower SME exemption threshold for non-established businesses (which could be set by each Member State or determined at EU level).

---

<sup>126</sup> Keen and Mintz, *"The optimal threshold for Value-added-tax"* (2004). See also 2017 Deloitte SME study, Volume I, p. 120.



Below, we have considered three possible scenarios, depending on which safeguards would be introduced as regards the cross-border use of the SME exemption<sup>127</sup>.

*Option 2A – No safeguards: SME exemption fully applicable*

The national SME exemption would be open to non-established EU businesses which meet the criteria set by the Member State of destination. The threshold(s) set by each Member State would apply in the same way to both domestic and non-established businesses. In this respect, the annual turnover to be taken into account would be that generated by a business in the Member State of destination only (with the exception of cross-border supplies which are deemed to be domestic, if the common EU threshold is applied). Use of the SME exemption in the Member State of destination would not preclude businesses from using the SME exemption in the Member State where they are established, if available.

This option has an advantage for the Member States of destination as it limits the control only to the turnover generated by supplies from non-established businesses in their territory. The main downside is that it will not prevent a situation of abuse where large companies with low turnover in each such Member State could apply the SME exemption.

*Option 2B – Safeguards: EU turnover threshold*

The national SME exemption would be open to non-established EU businesses which meet the criteria set by the Member States of destination, as explained in Option 2A. However, for a business to be able to apply the SME exemption, its overall EU turnover would have to be below a certain maximum threshold, set at EU level (e.g. EUR 100 000<sup>128</sup>). This EU turnover threshold would be calculated on the basis of the turnover derived from all supplies made by businesses within the EU, both domestic and cross-border. Its use would be compatible with the national SME exemption thresholds applicable in each Member State and the optional use of the common EU threshold<sup>129</sup>.

While the opening up of the SME exemption would be effectively targeted at small businesses, this option would require important efforts stemming from the need to control and monitor the turnover of companies generated at EU level.

*Option 2C – Safeguards: EU turnover threshold and limit in the application of the SME exemption*

The national SME exemption would be open to non-established EU businesses which meet the criteria set by the Member States of destination, as long as the EU turnover of the business remains below a certain maximum threshold, as explained in Option 2B. Moreover, Member States would be able to limit the extent to which such a business could apply the SME exemption they provide for, by means of a lower threshold specific for non-established businesses which could be set by each Member State or determined at EU level<sup>130</sup>.

---

<sup>127</sup> Examples of how each of these scenarios would work in practice can be found in Annex 7.

<sup>128</sup> The EUR 100 000 threshold is just illustrative. It corresponds approximately to the UK threshold which is the highest national threshold in the EU. To note, however, that businesses with less than EUR 50 000 of turnover are the ones most likely to be eligible for the SME exemption. See the 2017 Deloitte SME study, Volume I, p. 45.

<sup>129</sup> See Annex 7 for an example of how this option would work in practice.

<sup>130</sup> *Ibid.*

However, this option seems not viable for two main reasons.

Firstly, this option is likely to increase the complexity of the system, due to the use of multiple thresholds for exemption in each Member State (i.e. that for domestic businesses, and that for non-established businesses). If that limited threshold for non-established businesses was determined by each Member State, rather than set out at EU level for all Member States (e.g. EUR 5 000), the complexity would be even larger. It therefore seems that this option would make the system more complex and bring results which are inconsistent with the objective of reducing distortions.

And secondly, limiting the extent to which non-established business could apply the SME exemption by means of a specific threshold (lower than that applicable to established businesses) would imply treating established and non-established businesses in a different way. This could be seen as diverging from one of the general objectives of this initiative<sup>131</sup>, which is to contribute to the smooth functioning of a deeper and fairer Single Market.

#### Safeguards: preferred option

Although it may be difficult to control whether companies remain below the EU turnover threshold, **Option 2B would deliver the most appropriate outcome and it is thus the preferred one.** It would allow targeting the opening up of the SME exemption to SMEs only, while not increasing the number of applicable SME exemption thresholds and being in line with the functioning of the Single Market.

#### Streamlined simplified VAT obligations

The 2017 Deloitte SME study and the stakeholder consultation<sup>132</sup> confirmed the importance of simplified VAT obligations as a means to reduce compliance costs for SMEs and support their growth. It has been observed that the reduction of the compliance burden for SMEs varies substantially across Member States, depending on the simplified VAT obligations available<sup>133</sup>.

In particular, there was a general agreement among stakeholders as to the need to further simplify VAT obligations for SMEs<sup>134</sup>. The contribution XVIII.3.a by the Danish Business Forum received via the REFIT platform pointed precisely in this direction: ‘...VAT rules are not harmonised the consequence is that companies that begin to trade within the internal market often encounter difficulties. Not only are there major differences between the documentation requirements, requirements of signatures, invoice requirements and texts on the invoices, but the challenges are growing with the introduction of rules on reverse liability, various distinctions and definitions of delivery point and different rates of VAT’.

Currently, simplified VAT obligations for SMEs are optional for Member States and only applicable together with the exemption. Hence, the Directive does not allow Member States to provide less burdensome obligations for small businesses other than those that benefit from the exemption and are established in their territory.

---

<sup>131</sup> See section 4.1.

<sup>132</sup> See Annex 2.

<sup>133</sup> See Annex 8.

<sup>134</sup> In this respect, while business and business associations preferred such simplified VAT obligations to be mandatory for Member States, Member States were of the view that they should remain optional and adapt to the features of the national context.

Option 2 extends the application of simplified VAT obligations to both exempt and non-exempt small businesses, whether or not established in the Member State where they make supplies. Hence, this option also provides an alignment between different national practices, by introducing a common minimum set of simplified VAT obligations for all small enterprises.

Under this option the simplified VAT obligations would be available to:

1. Small enterprises with turnover below the SME exemption threshold:
  - i. Exempt
  - ii. Non-exempt (opting for the application of normal VAT rules)
2. Small enterprises with turnover above the exemption threshold and up to EUR [2 000 000] – non-exempt.

While making available simplified VAT obligations to all small enterprises, Option 2 also takes into account the fact that some of such enterprises will not have to collect and pay VAT (exempt), and others will have to do so (non-exempt). This has an impact on the minimum set of obligations which could be imposed in order to ensure correct functioning of the VAT system and effective control by tax authorities.

Option 2 tentatively covers the following common minimum set of simplified VAT obligations, which would distinguish between exempt and non-exempt small enterprises.

For exempt SMEs:

- Optional for Member States to either release from **registration**, or to provide for **simplified registration**.
  - Obligatory for Member States to provide for **simplified VAT record keeping**. Member States would be prevented from imposing on exempt SMEs bookkeeping obligations additional to the ones that are already in place based on the existing domestic regulation in other domains such as for direct taxation purposes or for accounting purposes.
  - Optional for Member States to release exempt small enterprises from the obligation to submit a **VAT return**. Where this option is not exercised – obligatory for Member States to open the possibility to submit a simplified VAT return covering the calendar year.
  - Obligatory for Member States to release from **invoicing** obligations.
  - The possibility for Member States to release exempt small enterprises from certain other or all obligations.
- 2) For non-exempt SMEs (SMEs with turnover below the exemption threshold, but opting for taxation on the basis of general principles + SMEs with turnover above the exemption threshold):
- Obligatory for Member States to provide for **simplified registration**.
  - Obligatory for Member States to provide for **simplified VAT record keeping**.
  - Obligatory for Member States to put in place (and optional for SMEs to use) **less frequent filing of VAT returns**.
  - Obligatory for Member States to apply certain simplification measures relating to the **VAT payment**.

The definition of enterprises with turnover above the exemption threshold which still qualify as SMEs, in the sense of the VAT Directive, refers tentatively to their annual turnover not exceeding EUR 2 000 000. This would be in line with the definition of micro-

enterprises according to the general SME definition, and would also follow other simplification measures available in the VAT Directive which are specific for businesses below EUR 2 000 000 (e.g. cash-accounting).

Figure 5 below illustrates the simplified VAT obligations under Option 2, as compared to the baseline scenario.

**Figure 5: Simplified VAT obligations under Option 2, as compared to the baseline scenario**

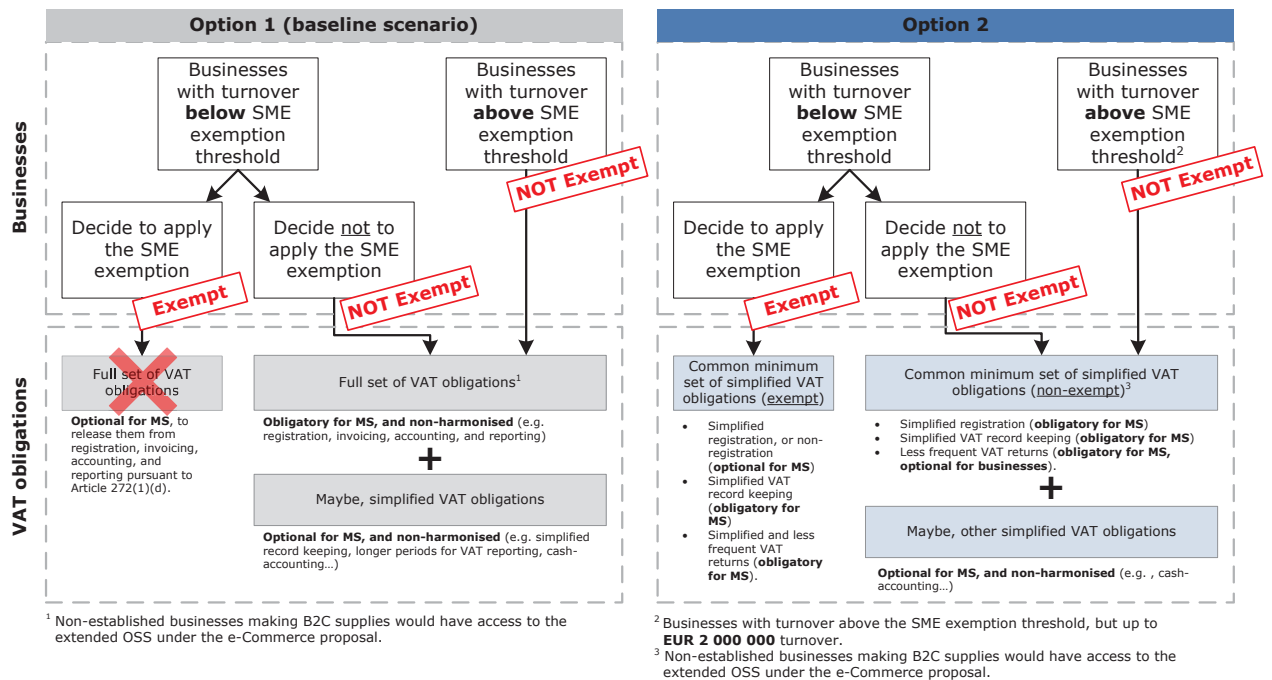

Source: Commission services

It is important to note that this option should be accompanied by the implementation of an EU web portal in order to provide non-established SMEs easy access to reliable information on the national SME schemes as well as on other relevant VAT provisions in the destination Member State. Stakeholders have indeed strongly supported during the consultation process this initiative which was also recommended under the REFIT platform (see submission XVIII.3.a by the Danish Business Forum<sup>135</sup>) as one of the main difficulties encountered by small businesses, which often are located in only one Member State, is the lack of information as regards the different VAT arrangements applied across the EU.

### The Commission's past experience

It should be noted that the Commission's experience strongly influenced the analysis and definition of policy options. In particular, the proposal for a Council Directive amending Directive 77/388/EEC with a view to simplifying value added tax obligations (COM(2004) 728 final) and the proposal for a Council Directive amending Directive 2006/112/EC on the common system of value added tax as regards a standard VAT return (COM(2013) 721 final) were taken into account. Both proposals were withdrawn by the Commission – the first one in 2014 and the second one in 2016 due to the lack of agreement among Member States. It should be kept in mind that the proposal for a Council Directive amending Directive 77/388/EEC with a view to

<sup>135</sup> [https://ec.europa.eu/info/sites/info/files/taxation\\_and\\_customs\\_union.pdf](https://ec.europa.eu/info/sites/info/files/taxation_and_customs_union.pdf)

simplifying value added tax obligations attempted to align the level of the SME exemption threshold by proposing a maximum threshold of EUR 100 000.

Option 2 was actually set in an attempt to balance the need to extend the scope of the exemption and to simplify obligations with the necessity to also take into account budgetary implications for the Member States and their need to ensure control of compliance with VAT laws.

As regards the exemption, the level of the threshold is on purpose proposed to be set below the level of the previously proposed threshold.

As regards obligations, Option 2 avoids re-opening of the discussion on the standard VAT declaration. The years of discussions on the latter resulted in the withdrawal of the Commission's proposal last year. However, Option 2 for the first time addresses the problem of compliance burden for small enterprises outside the exemption scheme.

### 5.2.3. *Option 3: Option 2 plus measures to reduce the negative impact of transition from exemption to taxation (the so-called 'threshold effect')*

According to the 2017 Deloitte SME study, SMEs can be discouraged to grow by the fact that the SME exemption as applied by most Member States does not allow a gradual passage from exemption to taxation, and that businesses exceeding the exemption threshold are immediately obliged to register for VAT, meet the standard VAT obligations and charge VAT on all their supplies. As a result of this, SMEs have an incentive to remain below the exemption threshold ('threshold effect'). Moreover, this issue reinforces the lack of neutrality of the current system and its distortive impacts.

This problem could be tackled by introducing some flexibility to the application of the SME exemption, and thus supporting SMEs' transition to full taxation. This could be done in several ways.

One option is the graduated relief<sup>136</sup>, already available in the VAT Directive<sup>137</sup>, according to which a business applying this measure would receive a VAT relief on part of their turnover, which gradually decreases with the increase of the turnover. However, this measure does not provide for simplified VAT obligations and it does not seem to be effective in practice, as confirmed by businesses and Member States during the stakeholder consultation<sup>138</sup>.

Another option would be to allow businesses exceeding the SME exemption threshold temporarily to continue using the SME exemption during a **transition period**<sup>139</sup>, which is the solution that we would favour.

As this would be a temporary measure, it ought to have an endpoint which could be either time-related (e.g. 1 year) or turnover-related (e.g. exceeding the threshold by a fixed percentage). The risk is that a solely turnover-related measure might lead to, in practice, having a higher SME exemption threshold which could be prone to abuse<sup>140</sup>. A combined measure allowing temporary

---

<sup>136</sup> Already applied by Spain, Netherlands, and Finland.

<sup>137</sup> See Article 282 of the VAT Directive. For more information, see section 1.3.6 and Annex 5.

<sup>138</sup> See Annex 2.

<sup>139</sup> Already applied by some Member States, such as Belgium and the UK.

<sup>140</sup> For instance, by businesses under-declaring their sales, so that their turnover does not formally exceed the 'higher' SME exemption threshold (that is, the SME exemption threshold plus the fixed percentage, under which businesses could benefit from the transition period).

continuation of the SME exemption for a limited time period and setting a maximum percentage by which the threshold can be exceeded would be more effective and could also limit the negative impact on VAT revenue<sup>141</sup>. Hence, Option 3 envisages two limitations:

- a time-related limitation: e.g. 1 year;
- a turnover-related limitation: e.g. exceeding the SME exemption threshold by 50%.

Under Option 3, businesses exceeding the SME exemption threshold could continue using the SME exemption for one more year or until their turnover exceeds the threshold by a certain percentage (e.g. 50%), whichever condition is met first.

This extended flexibility aims at reducing the negative impact of the ‘threshold effect’ and encouraging SMEs’ growth, since it would give businesses more time than is currently the case to prepare for having to apply the full set of VAT obligations, both financially and administratively. It would as well contribute to reducing the distortive impacts of the SME exemption. The measure would be optional for Member States and for businesses that would still have the possibility to opt out of the SME exemption.

During the stakeholder consultation, SMEs strongly agreed that small enterprises should be able to benefit from the SME exemption if their turnover temporarily exceeds the threshold. Business associations showed more discreet support and indicated that some anti-abuse measures should be foreseen. Likewise, Member States perceived the measure positively (some of them already use it domestically), provided that some anti-abuse measures are foreseen. In this respect, the time-related and turnover-related limitations address the concerns of business associations and Member States as regards possible abuse.

#### 5.2.4. *Option 4: Option 3 plus mandatory common treatment of occasional traders*

Technological developments create new opportunities for consumers and entrepreneurs as well as new forms of economic activity that blur the lines between consumers and businesses, that is, private and economic activity<sup>142</sup>. According to current rules<sup>143</sup>, any individual supplying goods or services, such as users of collaborative platforms<sup>144</sup> and private owners of photovoltaic installations<sup>145</sup>, may qualify as a taxable person within the meaning of the VAT Directive and thus be responsible for charging, collecting and paying VAT to the tax authorities. Such individuals normally qualify as small enterprises within the meaning of the VAT Directive and are therefore eligible for the SME exemption. However, the optional character of the exemption

---

<sup>141</sup> See 2017 Deloitte SME study, Volume I, p. 156.

<sup>142</sup> Communication from the Commission to the European Parliament, the Council, the European Economic and Social Committee and the Committee of the Regions – a European agenda for the collaborative economy ([COM\(2016\) 356 final](#)).

<sup>143</sup> According to Article 2 of the VAT Directive, supplies of goods and services are subject to VAT where they are made for consideration, within the territory of the Member State, by a taxable person acting as such. The notion of a taxable person as defined in the VAT Directive is very wide. It can be any person who, independently, carries out in any place any economic activity, whatever the purpose or results of that activity, pursuant to Article 9 of that Directive. Economic activity comprises any activity of producers, traders or persons supplying services. The concept of taxable person also covers the exploitation of tangible or intangible property for the purposes of obtaining income therefrom on a continuing basis.

<sup>144</sup> As regards the VAT treatment of users of collaborative platforms, see guidelines resulting from the 105<sup>th</sup> meeting of 26 October 2015 – Document B – taxud.c.1(2016)1162824 – 889: [VAT Committee guidelines](#) (p. 207).

<sup>145</sup> As regards the VAT treatment of owners of photovoltaic installations, as interpreted by the CJEU, see *Finanzamt Freistadt Rohrbach Urfahr*.

means that they can also opt for the application of normal VAT rules on the basis of which they have the right to deduct the input VAT which often results in substantial reimbursements as these traders have very small output tax. The cost to the respective national budgets may be significant.

The VAT treatment of an increasing number of occasional traders using collaborative economy platforms and other emerging technologies poses therefore significant challenges for Member States. In particular, VAT compliance control of such traders can be disproportionately burdensome for tax authorities. In addition, the assessment of whether these new traders actually qualify as taxable persons is not straightforward and has to be carried out on a case-by-case basis.

In addressing these issues, two alternative ways of VAT treatment for occasional traders have been assessed:

*Option 4A – Mandatory application of the SME exemption*

Under this option, an occasional trader would still be treated as a taxable person for VAT purposes, but the application of the SME exemption would be mandatory. Occasional traders would therefore not be able to opt out of the exemption unless a non-incidental business activity could be proven. Such traders would benefit from the SME exemption and consequently would be relieved from all or most of the VAT obligations. As a consequence of applying the exemption, that trader would not have the right to deduct VAT on inputs.

*Option 4B – Mandatory common treatment as non-taxable person*

With this second option, the occasional trader would be fully kept out of the VAT system, with no right to register for VAT and so no VAT related obligations. As regards purchases, the occasional trader would be treated as a final consumer with no right to claim back input VAT. Only if the trader proved to the tax authorities to carry out an economic activity on a regular basis his activities could become subject to VAT.

Preferred option

Both options for the common VAT treatment proposed above – if applied by Member States – would provide certainty for individuals engaging in incidental economic activity, especially where it involves an incidental cross-border transaction. From the perspective of the tax authorities it should reduce the administrative and monitoring costs (e.g. by reducing the number of voluntary VAT registrations) and would reduce the margin for VAT fraud (in particular on the input tax side).

However, **Option 4B** offers a more clear-cut treatment for occasional traders given the full relief of VAT obligations and from the perspective of tax authorities it has the most positive impact on administrative costs and revenues. Therefore, this would be the preferred of the two options.

Such a measure would be optional for Member States in order to provide them with the flexibility to apply it only when considered necessary. Since the measure is targeted at traders with incidental sales only, the impact on cross-border transactions and the place-of-supply rules is likely to be minimal.

The difficulty is to define the group of traders targeted by Option 4. The concept of ‘occasional traders’ is not contained in the VAT Directive. During the stakeholder consultation<sup>146</sup>, businesses and Member States recommended not to introduce new concepts at EU level but rather to clarify how Articles 9 and 12 of the VAT Directive should be applied in the circumstances described (e.g. through VAT Committee guidelines), in order to make for a better distinction between private and economic activity.

For the purpose of this analysis, occasional traders are meant to be private individuals carrying out an economic activity on an occasional basis outside of their main employment or an incidental economic activity that does not create distortions of competition and where the amount of VAT potentially collected is negligible. To identify the number of individuals impacted by this option, it was assumed that only those generating less than EUR 5 000 in turnover could potentially be classified as occasional traders.

### **5.3. Discarded options**

#### *5.3.1. Option 5: Option 2 with full harmonisation of the SME exemption threshold*

As set out in section 5.2.2, a fully harmonised SME exemption threshold at EU level could make the functioning of the exemption in a cross-border context easier for businesses. As mentioned above, the Commission has attempted to align the SME VAT schemes before, by proposing an increase of the maximum threshold to EUR 100 000. The main reasons for this were to provide Member States more flexibility in determining their thresholds (providing them more autonomy in setting up the most appropriate regime in view of the structure of their national economy) and remove the need for the use of the derogation procedure for any changes in the threshold, which is time consuming<sup>147</sup>. The discussions of this part of the proposal were stalled in the Council in 2007, and the proposal was eventually withdrawn by the Commission in May 2014.

Despite the fact that the proposal dates back from 2004, the difficulties standing in the way of agreement persist, as confirmed during the consultation process. They are mainly linked to the differences in economic and regulatory situation among Member States.

The identification of the appropriate level of the SME exemption threshold would indeed be the most challenging task as it should reconcile for all Member States the diverging needs of reducing administrative and compliance costs and collecting VAT revenues (or limiting negative revenue impact). The level at which domestic thresholds are currently set depends on several factors (e.g. compliance risks, economic system, resources, tax policy, environment) linked to the national context, which may differ significantly between Member States. That is why the exemption thresholds today range from slightly above EUR 3 000 to almost EUR 98 000 (see Annex 9).

For these reasons, the option including full harmonisation of the SME exemption threshold would have a very different impact on Member States and not necessarily bring a better result in terms of more level playing field.

---

<sup>146</sup> In particular, during the Fiscalis 2020 Workshop in Wroclaw (see Annex 2).

<sup>147</sup> COM(2004) 728, Proposal for Council Directive amending Directive 77/388/EEC with a view to simplifying value added tax obligations.



### 5.3.2. Option 6: Removing the SME exemption from the VAT Directive

Removing the SME exemption from the VAT Directive was not considered a desirable solution as it was not in line with the objectives of this initiative, in particular, with the need to reduce SMEs' burden related to the application of normal VAT rules.

Despite its optional nature, the SME exemption is the measure most widely implemented by Member States, and it is also used by a large number of small businesses, which represent an average take-up rate of 63% of eligible businesses<sup>148</sup>. Moreover, the SME exemption has been assessed as beneficial by both businesses and tax administrations during the stakeholder consultation, given that it eliminates the burden of small businesses of collecting and managing VAT and also allows tax administrations to focus on monitoring of larger businesses which generate a higher percentage of the revenues. In addition, the exemption lowers the compliance and administrative burden for businesses and tax authorities when combined with simplification measures.

The current Impact Assessment will therefore focus only on the first four options described above.

## 5.4. Key features of the proposed policy options

**Table 4: Overview of the key features of different policy options**

Features	Option 1	Option 2	Option 3	Option 4
<b>Territoriality of the exemption</b>	Only established businesses	Open to businesses established in other Member States, as long as they remain below a maximum EU turnover threshold	Like in Option 2	Like in Option 2
<b>Exemption thresholds</b>	SME exemption thresholds set in the VAT Directive or through derogations	Maximum EU-wide exemption threshold in the VAT Directive, Member States free to adopt lower thresholds	Like in Option 2	Like in Option 2
<b>Optionality of the exemption</b>	Optional for both Member States and businesses	Like in Option 1	Like in Option 1	Optionality not applicable to occasional traders (obligatory treatment)
<b>Simplified VAT obligations</b>	Some simplification measures linked to the use of the SME exemption (through Article 272) + some generally available	Common minimum set of simplified VAT obligations (for exempt businesses) +	Like in Option 2	Like in Option 2

<sup>148</sup> Based on the 2017 Deloitte SME study, Volume I, p. 128. The estimation of 63% is made on the basis of the data provided by some Member States only: Bulgaria, Croatia, Czech Republic, Estonia, France, Hungary, Lithuania, Luxembourg, Malta, Portugal, Slovakia, Slovenia, and UK. According to the study (Volume II, tables 29, 30, 75, and 76), it is nonetheless estimated that approximately 11 million businesses are exempt from VAT under the SME exemption in the EU generating a turnover of approximately EUR 109 billion per year.

Features	Option 1	Option 2	Option 3	Option 4
	simplified obligations – not all targeted at SMEs	Common minimum set of simplified VAT obligations (for non-exempt businesses)		
<b>Additional measures</b>	Common EU threshold (place of supply) for cross-border B2C supplies	Like in Option 1	Like in Option 1 + Flexibility for transitional period	Like in Option 3 + Mandatory common treatment of occasional traders as exempt or non-taxable persons

Source: Commission services

## 6. WHAT ARE THE IMPACTS OF THE DIFFERENT POLICY OPTIONS AND WHO WILL BE AFFECTED?

### 6.1. Methodology

The analysis of the policy options includes both qualitative and quantitative elements, which complement each other. For this analysis, it was necessary to collect information from the perspective of business and of Member States through desk research, surveys, interviews and workshops.

A range of methodological tools and different studies are used to assess the various impacts. Particularly, this analysis relies on the 2017 Deloitte SME study. Two tools of economic analysis were used: the standard cost model (SCM) and the computable general equilibrium (CGE) model.

The analysis of each option covers the following impacts:

- **Impact on businesses**, which includes the analysis of the number of businesses impacted and of their compliance costs;
- **Impact on Member States**, which includes the impact on VAT revenues, compliance and fraud, legislative framework and administrative costs;
- **Impact on the wider economy**, which includes the impact on GDP, aggregate output, output of impacted businesses, labour productivity, prices and consumer demand;
- **Other impacts** which include analysis of impact on consumers and households, as well as social impacts.

Given their target and the technical nature, the policy options are not expected to generate any direct or indirect environmental impacts. Therefore, impacts on the environment are not covered in the below analysis.

The overall analysis refers to businesses with annual turnover not exceeding EUR 2 000 000 (micro-businesses, according to the EU definition). However, the quantitative analysis (e.g. compliance costs) focuses on the specific sub-set of small enterprises with turnover below EUR 100 000, which represent approximately 32 million businesses. These businesses are the ones that are most likely to be eligible for the SME exemption under the current VAT legislation.

Although Options 2-4 include simplified VAT obligations for both exempt and not exempt small businesses with turnover of up to EUR 2 000 000, the impacts of these options on compliance costs take into account only the above mentioned sub-set of small enterprises.

A detailed description of the overall methodology used, the key assumptions and of the CGE model applied is included in Annex 4.

**Table 5: Summary of methodology used**

<b>Impact</b>	<b>Approach used</b>	<b>Data analysis methods</b>	<b>Key assumptions</b>	<b>Data collection methods</b>
<b>Impacts on businesses (including analysis of the number of businesses impacted and their compliance costs)</b>	Quantitative analysis Qualitative analysis	SCM	Elements from e-Commerce proposal Number of SMEs Scenarios with different levels of simplification for SMEs Business behaviour when engaged in cross-border B2C supplies Sensitivity parameters	Member State questionnaires SME panel consultation, open public consultation and Fiscalis 2020 Workshop 2017 Deloitte SME study, other existing studies and relevant literature
<b>Impacts on Member States (including impact on VAT revenues, compliance, legislative framework and administrative costs)</b>	Quantitative analysis Qualitative analysis	SCM	Elements from e-Commerce proposal Effective VAT rate at EU level Weighted average exemption threshold Scenarios with different levels of simplification for SMEs Compliance monitoring based on risk profiling	Member State questionnaires SME panel consultation, open public consultation and Fiscalis 2020 Workshop 2017 Deloitte SME study, other existing studies and relevant literature
<b>Impacts on wider economy (including impact on GDP, aggregate output, output of impacted businesses, labour productivity, prices and consumer demand)</b>	Quantitative analysis	CGE model	Group of SMEs Business behaviour when engaged in cross-border B2C supplies Sensitivity parameters	2017 Deloitte SME study
<b>Impacts on consumers and household</b>	Qualitative analysis	Projections	Number of SMEs	Existing studies and relevant economic literature Desk research

<b>Social impacts</b>	Qualitative analysis	Projections	Number of SMEs	Existing studies and relevant economic literature Desk research
-----------------------	----------------------	-------------	----------------	--

Source: Commission services

## 6.2. Analysis of the impacts of each of the options

### 6.2.1. Option 1 – *Status quo*, including e-Commerce changes

Option 1 builds on the current legislative framework of the VAT Directive and integrates the changes included in the e-Commerce proposal. It represents the baseline, against which the other policy options are evaluated.

Section 2 outlines in detail the problems related to the baseline scenario. Its main impacts are summarised below.

It should be noted that the quantitative impacts (e.g. compliance costs) of the policy options only cover the specific sub-set of small enterprises with turnover below EUR 100 000. However, businesses with annual turnover above EUR 100 000 and up to EUR 2 000 000 will be also impacted by the policy options. The overall analysis therefore covers small businesses with turnover from zero to EUR 2 000 000.

#### **Compliance costs for SMEs**

The overall compliance costs that small businesses (with turnover below EUR 100 000) face to comply with VAT obligations are estimated at a total of **EUR 68 billion** per year. This figure does not take into account compliance costs currently faced by small businesses with turnover exceeding the turnover threshold of EUR 100 000 but remaining below EUR 2 000 000, which could not be estimated.

Within this figure are included three main groups of businesses: businesses using the SME exemption, businesses using domestic standard VAT regimes and businesses engaged in cross-border trade irrespective of whether or not they use the SME exemption for their domestic transactions.

As regards businesses trading domestically, the EU average compliance costs (including advisory costs) are estimated at:

- EUR 550 (weighted average) per year for a business benefitting from the current SME exemption. Such businesses represent around 11.2 million across the EU and bear an overall compliance cost of **EUR 6.1 billion**;
- EUR 2 970<sup>149</sup> (of which advisory fees are about EUR 1 023) per year for a business outside the SME exemption, which is eligible for the exemption but decided to opt out. The higher costs are due to the fact that businesses operating under the standard VAT regime have to comply with the whole set of VAT obligations. These represent around

<sup>149</sup> However, VAT compliance costs range from EUR 870 to EUR 2 970 depending on the frequency of the obligations, complexity of the legislative framework in Member States, advisory costs and additional costs, such as IT.

5.7 million businesses across the EU and are estimated to have an overall compliance cost of EUR **16.9 billion**.

- **Businesses not eligible for the SME exemption** which operate in the standard VAT regime are estimated to represent an additional **15 million businesses** facing overall VAT compliance costs of **EUR 44.5 billion**.

These figures underline the relevance of the SME exemption in reducing VAT compliance costs of small businesses in domestic trade.

In the context of cross-border B2C trade SMEs are more than proportionally affected by VAT compliance costs compared to larger businesses. The overall costs that a business faces when engaging in such trade amount on average to EUR 7 800 for each Member State in which it is VAT-registered, while the costs for SMEs are about EUR 5 000<sup>150</sup>.

Under this option, SMEs engaged in intra-EU B2C trade, have the following options for accounting and paying VAT:

- treat cross-border B2C sales as domestic supplies if total sales are below the common EU threshold of EUR 10 000 and possibly apply the domestic SME exemption;
- declare and pay VAT using the extended One Stop Shop (OSS);
- register for VAT in the Member State of destination and apply the standard VAT regime.

When total cross-border B2C sales exceed EUR 10 000, using the extended OSS is likely to be the most pragmatic and effective option, given that it reduces significantly the annual compliance costs, with significant economies of scale, compared to the possibility to apply the standard VAT regime.

As regards businesses trading cross-border, it is therefore estimated that:

- if the extended OSS is applied, the overall VAT compliance costs amount to about EUR 400 million per year (EUR 690 per business);
- if the standard VAT regime is applied, the annual cost of full VAT registration in another Member State is about EUR 4 700 per Member State with the possibility to recover input VAT directly.

Because for cross-border B2B sales the reverse charge mechanism applies<sup>151</sup>, it is for all policy options assumed that the supplier would not have any VAT obligations in the Member State of destination. Therefore, the compliance costs for such transactions are already included in the analysis of the domestic compliance costs for businesses in Option 1.

---

<sup>150</sup> Deloitte (2016) 'VAT Aspects of cross-border e-commerce – Options for modernisation', Final report – Lots 1 and 2.

<sup>151</sup> The supplier of a good or a service is considered for VAT purposes to be the person liable to pay the VAT collected to the Treasury (Article 193 of the VAT Directive). However, under particular circumstances (Articles 194 to 199b of the VAT Directive), the VAT Directive provides for (or allows Member States) the application of the so-called reverse charge mechanism that deviates from this rule. Under a reverse charge, the liability is moved to another person, in general the customer.

It should be noted that due to the common EU threshold, compliance costs for intra-EU B2C supplies which are below EUR 10 000 are included in the estimation of domestic compliance costs.

### **Competitiveness and growth obstacles for SMEs**

For SMEs the necessity to deal with different national VAT rules and administrative procedures constitutes a fixed-cost market-entry barrier. It discourages them from trading cross-border and prevents their growth. Available evidence suggests that only about 15% of SMEs trade cross-border<sup>152</sup>.

The 2015/2016 Deloitte e-Commerce study<sup>153</sup> estimates that, with the elimination of the compliance burden, the value of cross-border B2C e-Commerce may potentially increase by 1.2%-2.6%. This change represents an increase in the value of e-Commerce of between EUR 2.5 billion and EUR 4.2 billion annually.

This option, as a result of the e-Commerce changes, provides SMEs with some limited support to cross-border activity but it does not align the SME exemption with the destination principle and the distortions between domestic and non-established businesses remain unsolved<sup>154</sup>.

### **Compliance levels and fraud in Member States**

The main concerns for tax administrations with the current SME exemption relate to under-declaration of sales by businesses in order to stay below the threshold and to disproportionate input VAT claims by businesses opting out of the exemption.

On one hand, compliance control of businesses benefitting from the SME exemption can be difficult due to the full or extensive relief from VAT obligations that is often applied, which generally means that the tax authorities have very limited information on the number of such businesses and their turnover. On the other hand, the benefits of this exemption for tax authorities, which enables better allocation of resources while keeping a large number of small businesses out of the VAT regime, outweigh the risk of non-compliance and abuse.

The introduction under the e-Commerce proposal of the common EU threshold of EUR 10 000, under which cross-border B2C supplies can be deemed as domestic supplies, is likely to be positive for small businesses that have limited cross-border B2C sales. The threshold is expected to improve compliance among such businesses as they do not have to comply with rules of the Member States of destination. Also the removal of distance selling thresholds is expected to facilitate compliance control by tax authorities, reducing VAT fraud on distance selling.

---

<sup>152</sup> 2017 Deloitte SME study, Volume I, section 7.2.1.

<sup>153</sup> Deloitte (2016) 'VAT Aspects of cross-border e-commerce – Options for modernisation', Final report – Lot 2.

<sup>154</sup> For more information about the interaction between the e-Commerce proposal, the definitive VAT system proposal and the SME VAT package, see Annex 6.

6.2.2. Option 2B – SME exemption extended to supplies from other Member States with EU turnover threshold and including streamlined simplification measures

**Summary – the extent to which the specific policy objectives will be met**

**Overall – Objectives partially met**

1. Reducing VAT compliance costs for SMEs – Met
2. Reducing distortions – Met
3. Reducing the negative impact of the threshold effect – Not met
4. Facilitating compliance and monitoring – Met to a large extent if sufficient control arrangements are put in place to monitor the SME turnover generated EU-wide
5. Reducing revenue losses caused by occasional traders – Not met

**Economic impacts and competitiveness**

**Impact on businesses**

In comparison with the baseline scenario, Option 2B leads to a reduction of VAT compliance costs of between 8% and 22% depending on the common set of obligations included in the SME package. These estimates refer to only small businesses with turnover below EUR 100 000. However, given that also non-exempt small businesses with turnover of up to EUR 2 000 000 may benefit from simplified obligations, the compliance cost reduction under this option is expected to be more significant.

For the purpose of this analysis three scenarios with different levels of simplification were considered, under which the number of obligations to be complied with moves from a very simple set of obligations (scenario 1) to the broadest set of obligations (scenario 3). It should be noted that, following the extension of the scheme to non-established businesses, VAT registration is included as mandatory obligation in all scenarios for control reasons. However, Member States currently relieving exempt businesses from all VAT related obligations (included VAT registration) could continue to do so if the eligible business carries out only domestic transactions. In that case, compliance costs for the exempt domestic businesses are equal to zero<sup>155</sup>.

Table 6 below summarises the sets of obligations included in each of the scenarios and their projected impact on compliance costs.

**Table 6: Simplification scenarios linked to Option 2 and their impact on compliance costs**

Set of VAT obligations	High level of simplification (scenario 1)	Medium level of simplification (scenario 2)	Minimal level of simplification (scenario 3)
Using SME exemption	<ul style="list-style-type: none"> <li>▪ VAT registration (only in cross-border trade)</li> <li>▪ Bookkeeping</li> </ul>	<ul style="list-style-type: none"> <li>▪ VAT registration</li> <li>▪ VAT return</li> <li>▪ Bookkeeping</li> </ul>	<ul style="list-style-type: none"> <li>▪ VAT registration</li> <li>▪ Invoicing</li> <li>▪ VAT return</li> <li>▪ Bookkeeping</li> </ul>
Opting out of SME exemption	<ul style="list-style-type: none"> <li>▪ VAT registration</li> </ul>	<ul style="list-style-type: none"> <li>▪ VAT registration</li> </ul>	<ul style="list-style-type: none"> <li>▪ VAT registration</li> </ul>

<sup>155</sup> See Table 23 in Annex 8 showing compliance costs faced by small businesses in five selected Member States.

	<ul style="list-style-type: none"> <li>▪ VAT return</li> <li>▪ VAT payment</li> <li>▪ Bookkeeping</li> </ul>	<ul style="list-style-type: none"> <li>▪ VAT return</li> <li>▪ VAT payment</li> <li>▪ Bookkeeping</li> </ul>	<ul style="list-style-type: none"> <li>▪ Invoicing</li> <li>▪ VAT return</li> <li>▪ VAT payment</li> <li>▪ Bookkeeping</li> </ul>
<b>Overall compliance costs</b>	<b>53.2 billion</b>	<b>58.6 billion</b>	<b>62.7 billion</b>
<b>% compliance costs from option 1 (=100%)</b>	<b>-22%</b>	<b>-14%</b>	<b>-8%</b>

Source: Commission services on the basis of the 2017 Deloitte SME study

### **Businesses trading domestically**

This option is estimated to reduce on aggregate the compliance costs of SMEs trading domestically. However, the impact differs significantly across Member States, depending on the measures currently applied to SMEs and on the different scenarios considered for the streamlined simplification package.

As regards businesses using the SME exemption, under the high simplification scenario, compliance costs are expected to diminish on average by 46%<sup>156</sup>. Under the minimal simplification scenario, the option may lead to an increase in compliance costs for domestic businesses benefitting from the SME exemption in other Member States, as they may become subject to additional obligations, such as registration.

As regards businesses opting out of the SME exemption, in all simplification scenarios the compliance costs are estimated to decrease by between 65% and 70% (EUR 975 per business, under the medium scenario, compared to the baseline cost of about EUR 3 000)<sup>157</sup>.

Option 2B can be therefore said to support the growth of both exempt businesses and businesses for which the exemption is less suited (e.g. those which trade mostly B2B or have a high amount of input VAT which can be deducted only if outside the exemption scheme).

### **Businesses trading cross-border**

Under this option, businesses trading cross-border may benefit from the SME exemption in the Member State of destination. It is assumed that only businesses making cross-border B2C supplies will be affected by the option as currently SMEs do not have to pay VAT on intra-EU B2B supplies. However, depending on the type of business, SMEs engaged in cross-border B2B trade could potentially benefit from the simplification package in other Member States.

A number of businesses could benefit from the common EU threshold introduced by the e-Commerce proposal and will be able to apply domestic VAT exemption to supplies below that threshold. That is why the number of businesses that could benefit from Option 2B is estimated at only about 580 000, representing 1.4% of all businesses<sup>158</sup>. Among these, the cost of VAT compliance will depend on whether they opt to use the extended OSS or to register in the Member State of destination (either within or outside the SME exemption). The results of the SCM analysis indicate that use of the extended OSS costs on average EUR 690 whereas the

<sup>156</sup> 2017 Deloitte SME study, Volume I, p. 169.

<sup>157</sup> *Ibid.*

<sup>158</sup> *Ibid.*



cost of VAT registration in another Member State may vary between close to EUR 300 and EUR 1 040, depending on the level of simplification adopted by Member States<sup>159</sup>.

An overview on the number of businesses impacted by the option and their compliance costs under different scenarios is outlined in section 4 of Annex 4.

## **Impact on Member States**

### **VAT revenues**

The extension of the SME exemption to non-established businesses has potentially negative impacts on VAT revenues, as SMEs currently pay VAT on their cross-border B2C sales whereas according to this option they may use the SME exemption in the Member States of destination. However, it is estimated that the value of sales that would no longer be subjected to VAT is only about 0.02% of the overall EU turnover<sup>160</sup>.

With Option 2B, VAT revenues are expected to decrease up to EUR 665 million or 0.06%, compared to the current level of net VAT revenue collected by Member States in the EU.

Any potential negative revenue impact could be mitigated by adjusting the national exemption thresholds, so that the policy changes are potentially revenue neutral. Such downward adjustments could impact domestic businesses currently benefitting from the SME scheme.

### **Compliance and fraud**

This option is expected to increase the complexity of the SME exemption and change the compliance, abuse and fraud risks associated with the scheme. As a result, it may increase compliance control costs for tax authorities. The option will also increase the need for administrative cooperation between the tax authorities of different Member States in order to ensure compliance control of foreign businesses.

The impact on avoidance or abuse/fraud relating to the SME exemption will largely depend on the national design, on which simplification measures are included in the scheme and how they are applied.

The option should not have a significant impact on the compliance of domestic businesses, unless current simplification measures are significantly changed. At the same time the extension of simplification measures to SMEs that have opted out of the SME exemption is likely to improve voluntary compliance.

### **Legislative and administrative impact**

As a result of this option, the tax authorities will need to make legislative changes to their current SME exemption, unless they have decided not to apply it. They may also need to review simplification measures currently applied.

The impact on the administrative costs for the Member States will depend on the simplification measures applied as part of the SME exemption. The set of simplification measures will need to

<sup>159</sup> 2017 Deloitte SME study, Volume I, p. 170.

<sup>160</sup> *Ibid.*

be balanced against the interests of the tax authorities in controlling compliance with the scheme and tackling any risks of abuse.

Compared with the current VAT framework, the administrative costs of tax authorities are expected to increase, at least in the short term.

### Impact on the wider economy

The effects of Option 2B on the wider economy were tested with the use of the CGE model. Overall, the analysis shows that the policy change should have a positive impact on the wider economy.

**Table 7: Summary table of the wider economic impact of Option 2**

	High level of simplification (scenario 1)	Medium level of simplification (scenario 2)	Minimal level of simplification (scenario 3)
Impact on GDP	0.11%	0.07%	0.04%
Impact on aggregate output	0.13%	0.08%	0.05%
Impact on output of impacted SMEs	14.0%	9.0%	5.0%
Impact on SMEs' cross-border trading activity (percentage change in total value of cross-border trade)	13.5%	13.5%	13.1%
Impact on labour productivity	0.14%	0.09%	0.05%
Impact on prices	-0.10%	-0.08%	-0.05%
Impact on consumer demand	0.14%	0.09%	0.05%

Source: 2017 Deloitte SME study

### SMEs' output

Under this option, the activity of domestic SMEs is estimated to increase by up to 14% due to the significant reduction in compliance costs and the associated increase in their productivity and competitiveness. For businesses that trade cross-border, the policy change can lead to a reduction of VAT costs by over 12% and a reduction of the compliance burden associated with such trade by up to 30%. Together, these impacts may enable increases in cross-border activity by affected SMEs of up to 13.5%, as they are better able to compete with SMEs in the Member States with which they trade<sup>161</sup>.

### Consumption and labour productivity

The reduction in compliance burden and the extension of the SME exemption can reduce prices and increase consumption. Given that the businesses affected only account for a small fraction of EU turnover, the impact on the overall price level will however not be significant.

By reducing the time spent in unproductive tasks, the reform also has the potential to increase labour productivity, which in turn can increase real wages and reduce working hours.

<sup>161</sup> 2017 Deloitte SME study, Volume I, p. 175.

## Consumers and households

The impact on consumers is likely to be positive overall as more businesses are likely to engage in intra-EU trade. The improvement of competitiveness for SMEs will allow them to charge lower prices and bring other benefits for consumers, such as better quality, wider choice and innovative goods and services.

## Social impacts

A positive impact on employment may be expected due to an increase in cross-border trade and the improvement in the conditions for competition for both domestic SMEs and SMEs established in other Member States.

No figures are available for this impact although it is likely to be relatively small.

### 6.2.3. Option 3 – Option 2B plus measures to reduce the negative impact of transition from exemption to taxation

## Summary – Impact on the policy objectives

### Overall – Meets the objectives to a large extent (Positive overall)

1. Reducing VAT compliance costs for SMEs – Met
2. Reducing distortions – Met
3. Reducing the negative impact of the threshold effect – Met
4. Facilitating compliance and monitoring – Met to a large extent
5. Reducing revenue losses caused by occasional traders – Not met

## Economic impacts and competitiveness

### Impact on businesses

The overall compliance costs for businesses under Option 3 amount to approximately **EUR 56.1 billion** (or an 18% reduction compared to the baseline scenario). The estimation takes into account the set of VAT obligations under the medium simplification scenario of Option 2 compared to which Option 3 leads to an additional reduction in compliance costs for businesses of 4%.

It should be noted that these impacts refer to only small businesses with turnover below EUR 100 000. The compliance cost reduction under this option is expected to be higher given that also non-exempt small businesses with turnover of up to EUR 2 000 000 will be effected.

**Table 8: Overview of the impacts on compliance costs for businesses under Option 3**

	Cost per 1 business (1 MS) EUR	No of businesses	Compliance cost (EUR billion)
<b>Businesses trading domestically</b>			
Businesses exempt from VAT	[716 – 1 043]	7 400 000	7.7
Businesses in simplified regime	[975 – 1 208]	4 200 00	5.0
Businesses in transitional period	1 325	260 000	0.34
Businesses in standard VAT regime	[2 964 – 3 104]	13 700 000	42.6

<b>Businesses trading cross-border</b>			
Businesses using extended OSS	690	290 000	0.20
Businesses in cross-border exemption scheme	716	290 000	0.21
<b>Overall compliance costs</b>			<b>56.1</b>
<b>% change from baseline scenario</b>			<b>-18%</b>

Source: 2017 Deloitte SME study

The number of businesses that could be impacted by the transition period is estimated on average at around 260 000 (0.6% of all EU businesses) in a given year.

Option 3 is expected to have a general positive impact on SMEs' growth, by providing a transition period for businesses in order for them to prepare for the standard VAT regime and the larger set of VAT obligations, which includes at least some of the following:

- understanding of the VAT system (use of advisors/accountants);
- changing from annual to quarterly (or even monthly) accounting;
- providing information to the tax authorities; and
- re-calculating of sales prices (and possible setting of new pricing policy).

During the transition period, impacted businesses will face higher costs compared to those under Option 2, given that they will prepare to comply with the full set of VAT obligations and for the full taxation in the following period. It is therefore estimated that, during this period, their compliance costs will increase by up to EUR 1 325 (36% higher than the estimated costs for a business using only the streamlined simplification package). This way, the subsequent increase to the full set of VAT obligations (quantified at approximately EUR 2 964 per year) is expected to be less significant.

## **Impact on Member States**

### **VAT revenues**

Option 3 is expected to have a temporary negative impact on the VAT revenue of Member States, as it extends for a limited period the application of the exemption for those businesses that exceed the threshold. However, in the longer term the revenue impact has the potential to be positive, due to the general positive effect on the SMEs' output and as a result of reduction in the 'threshold effect' (more declared sales).

This option alone is expected to lead to a reduction in VAT revenue at EU level of 0.18%. Combined with the impacts of Option 2, the overall effect on VAT revenue is a decrease of 0.24%.

Estimates show differences in revenue impact across Member States and in the number of businesses impacted that can be explained by the different levels of thresholds (the higher the threshold, the higher the impact). The impact on the revenue of each Member State is outlined in section 4 of Annex 4.

### **Compliance and fraud**

This option is expected to have a positive impact on voluntary compliance by reducing under-declaration of sales by SMEs done in an attempt to avoid exceeding the SME exemption threshold. The risk of abuse is considered limited due to the scope of the option and Member States' ability to take measures to control compliance, for example by requiring businesses to

notify application of the transition period.

The option may increase the complexity of the SME exemption and related compliance control costs for tax authorities.

### **Legislative and administrative impact**

Member States wishing to provide for a transition period would need to make limited additional legislative changes. There may be also a need for transitional measures whenever such change is implemented.

The option should not have significant impacts on the administrative cost of the tax authorities, although there may be a limited one-off cost for the implementation of this measure.

### **Impact on the wider economy**

Option 3 can have further positive impact on the wider economy. In particular, the option is expected to have the greatest impact on prices and output compared to the other policy options considered, since it extends the benefits of the SME exemption to fast-growing SMEs.

While the overall impact on output is small, the measure may enable businesses affected to increase their economic activity by over 16%. This is due both to the fact that these businesses do not need to charge VAT on supplies (potentially reducing prices by 0.11%) and to a significant reduction in compliance costs, albeit limited in time, from an estimated EUR 3 000 to EUR 1 300. Given that these SMEs would be able to smooth the fixed costs associated with full VAT registration over a longer period, it can also make it easier for these businesses to compete with larger businesses that are more accustomed to dealing with VAT obligations.

**Table 9: Impact of Option 3 on the wider economy**

<b>Option 3: Option 2 plus measures for transition period</b>	
Impact on GDP	0.09%
Impact on aggregate (see Option 2) output	0.10%
Impact on output of impacted SMEs (i.e. businesses in the transitional period)	16.1%
Impact on SMEs' cross-border trading activity (percentage change in total value of cross-border trade)	13.5%
Impact on labour productivity	0.11%
Impact on prices	-0.11%
Impact on consumer demand	0.12%

Source: 2017 Deloitte SME study

### **Consumers and households**

Similar to Option 2, the impact on consumers is likely to be positive as the improvement of business competitiveness will allow SMEs to charge lower prices and bring other benefits for consumers, such as better quality, wider choice and innovative goods and services.

## Social impacts

Similar to Option 2B, improvement in competitiveness should stimulate productivity and employment growth in the long-term.

### 6.2.4. Option 4 – Option 3 plus mandatory common treatment of occasional traders

#### Summary – Impact on the policy objectives

##### Overall – Meets all the objectives (More positive overall)

1. Reducing VAT compliance costs for SMEs – Met
2. Reducing distortions – Met
3. Reducing the negative impact of the threshold effect – Met
4. Facilitating compliance and monitoring – Met to a large extent
5. Reducing revenue losses caused by occasional traders – Met

#### Economic impacts and competitiveness

##### Impact on businesses

Under Option 4, the overall compliance costs for businesses are estimated at approximately **EUR 56.5 billion**<sup>162</sup> (or a 17% reduction compared to the EUR 68.0 billion estimated under the baseline scenario). This reduction is essentially due to the decrease in the number of businesses subject to VAT-related obligations.

Table 10 below provides an overview of the compliance costs for businesses with less than EUR 100 000 of turnover, excluding occasional traders, under the medium simplification scenario of Optionv2 and on standard VAT regime where no exemption is offered.

**Table 10: Businesses' compliance costs under Option 4**

	Cost per 1 business (1 MS) EUR	Previous compliance cost of an occasional trader	No of businesses	Compliance cost (EUR billion)
<b>Businesses trading domestically</b>				
Businesses exempt from VAT	[716 – 1 043]	83	7 400 000	7.7
Businesses in simplified regime	[975 – 1 208]	342	4 200 000	5.0
Businesses in standard VAT regime	[2 964 – 3 104]	1 114	14 000 000	43.4
<b>Businesses trading cross-border</b>				
Businesses using the extended OSS	690		290 000	0.20

<sup>162</sup> The estimates refer only to the treatment of occasional traders as non-taxable persons. However, the reported impacts can be indicative impacts also for the mandatory application of the SME exemption, due to the very similar implications resulting from the two VAT treatments proposed for the occasional traders in the present Impact Assessment. See the 2017 Deloitte SME study, Volume I, p. 176.

Businesses in cross-border exemption scheme	716		290 000	0.21
<b>Overall compliance costs</b>				<b>56.5</b>
<b>% change from baseline scenario</b>				<b>17%</b>

Source: 2017 Deloitte SME study

Based on the information collected from some Member States, it is expected that 40% of businesses with less than EUR 5 000 turnover could be classified as occasional traders (15.1% of all EU businesses). As a consequence, the number of businesses directly impacted by this option is estimated at about **6.4 million**, out of which 3.8 million (or about 60%) are businesses already exempt from VAT under domestic schemes.

The impact on occasional traders will vary depending on their current VAT status and the simplification measures currently applied by Member States. Compliance costs are estimated at around EUR 80 for traders exempted from VAT, about EUR 340 for those eligible to the exemption scheme but opting out and using the simplification package, and about EUR 1 110 for those where no exemption is on offer.

## Impact on Member States

### VAT revenues

The data from tax authorities revealed that small businesses with less than EUR 5 000 in turnover on average contribute negatively to the net VAT revenue collected at EU level. Therefore, by preventing these businesses from opting out so as to be able to recover VAT on their inputs Option 4 may increase governments' revenue by up to 0.52%. However, the overall direction of the impact on revenues is uncertain. For the purposes of this Impact Assessment it is cautiously estimated at a decrease of 0.24%.

### Compliance and fraud

This option is expected to have a positive impact on compliance, as the impacted occasional traders, who currently may be non-compliant, can legally stay out of the VAT system or be VAT exempted and will be relieved from all or some of the VAT-related obligations. However, in terms of those established outside the Member State of taxation, it could be very challenging for Member States to determine who occasional traders are.

The risk of businesses abusing the measure is considered low, as in the majority of Member States such businesses could in any case benefit from the optional SME exemption scheme.

The option is expected to reduce voluntary VAT registrations and related risks of input VAT fraud. Keeping occasional traders out of the VAT system would allow tax authorities to reduce compliance control costs and better target their resources.

### Legislative and administrative impact

Member States would have the option to legislate for the mandatory common treatment of occasional traders as non-taxable persons. If the option is implemented, the main challenge would be to define 'occasional traders' (or the scope of the measure) for national purposes and provide relevant guidance to potentially impacted traders. In such a case, Member States would also need to deal with the transition from the current VAT treatment of occasional traders to the treatment as non-taxable persons, especially where the trader is already registered for VAT. For

example, they could require traders who are VAT registered voluntarily to provide evidence that they are not ‘occasional traders’.

This option is expected to have a mixed but overall positive impact on tax authorities’ administrative costs. The tax authorities would have a one-off administrative cost from introducing and managing the transition to the new regime, e.g. reviewing a number of existing VAT registrations that may be impacted by the option. Ongoing administrative costs would be reduced, as the number of voluntary registrations is expected to reduce, and therefore the tax authorities would need to manage and control smaller numbers of taxpayers.

### Impact on the wider economy

The impacts on the wider economy are generally greater than those estimated under Option 3. The fact that occasional traders are relieved of the VAT-related obligations will lead to a further reduction in the overall compliance cost. Also the overall impact on output will be positive and occasional traders may increase their activity by up to 11%.

**Table 11: Impacts of Option 4 on the wider economy**

<b>Option 4: Treatment of occasional traders as exempt or non-taxable persons</b>	
Impact on GDP	0.09%
Impact on aggregate output	0.10%
Impact on output of impacted SMEs (i.e. occasional traders)	10.9%
Impact on SMEs’ cross-border trading activity (percentage change in total value of cross-border trade)	13.5%
Impact on labour productivity	0.11%
Impact on prices	-0.09%
Impact on consumer demand	0.11%

Source: 2017 Deloitte SME study

### Consumers and households

The change will further contribute to the improvement of business competitiveness which stimulates productivity and brings positive benefits for consumers (e.g. better quality, wider choice of goods and services at affordable prices). However, given that the businesses affected in particular by Option 4 contribute a very small amount to EU-wide turnover, the impact on consumers is not significant.

### Social impacts

By establishing a common VAT legal framework for occasional traders Option 4 will bring legal certainty for both businesses and citizens, encouraging a more confident participation in the collaborative economy. Greater competitive conditions should boost productivity and lead to long-term employment growth.



## 7. HOW DO THE OPTIONS COMPARE?

### 7.1. Summary assessment of the impacts

Results from the Impact Assessment show that the most important impact of the policy options is the reduction of VAT compliance costs for SMEs. Compared to the baseline scenario, all options reduce compliance costs for businesses, though to a different extent. The overall compliance costs of EUR 68 billion that approximately 32 million businesses<sup>163</sup> (with an annual turnover below EUR 100 000) face under the baseline scenario are reduced to between EUR 58.6 billion and EUR 56.1 billion depending on the option. To this one should be added the impact on businesses with turnover above the SME exemption threshold and up till EUR 2 000 000, for which some simplification of obligations will be also offered. These businesses, similarly to those with a turnover below the SME exemption threshold, but opting out of the exemption<sup>164</sup>, may benefit from simplification measures that would reduce their costs by between 8 and 22%, depending on the simplification scenario.

As a consequence, the options should contribute to increasing SMEs' cross-border trading and impact positively on GDP, aggregate output, output of impacted SMEs, labour productivity, consumer demand and prices.

This being said, one should also keep in mind the impact, difficult to quantify, on legal certainty and on efficiency of the VAT rules in general. The review, whichever option is chosen, would result in updating the VAT system, making it better adapted to the economic reality<sup>165</sup> and making it sustainable in the future system of VAT with taxation based on the destination principle.

All the options have a minimal negative effect on VAT revenues, given that the overall VAT revenue contributed by SMEs at EU level is quite small. It should be noted, however, that due to the general positive effect on the SMEs' growth, the revenue impact has the potential to be positive in the longer term.

**Option 2.** Through the simplified VAT obligations and the extension of the SME exemption to non-established EU businesses, this option impacts directly the compliance costs of all businesses, trading domestically as well as cross-border. The reduction in compliance costs ranges from 8% to 22% (-14% under the medium simplification scenario), depending on the extent to which Member States simplify or increase the VAT-related obligations of SMEs. In terms of compliance and fraud, this option is less positive, as it brings some complexity into the scheme for SMEs which would make it more difficult for tax authorities to monitor. The option meets to a large extent the orientations resulting from all stakeholder consultation activities.

**Option 3.** The transitional period offered under this option allows SMEs to remain within the SME exemption for a limited additional period of time. This should lead to a reduction in compliance costs of 18% compared to the baseline (additional reduction of EUR 2.5 billion in respect of compliance costs under the medium simplification scenario of Option 2), reduce the threshold effect and provide SMEs an incentive to grow. The impact on compliance and fraud is expected to be positive due to the fact that the policy change will reduce under-declaration of

---

<sup>163</sup> 2017 Deloitte SME study, Volume I, p. 161.

<sup>164</sup> See section 6.2.2 on the assessment of the impacts of Option 2.

<sup>165</sup> See, for example, the issue of the update of the thresholds as set out originally in 1977 at the level of EUR 5 000.

sales. Compared to the other options, this option has the greatest impacts on the wider economy and revenues, since it extends the benefits of the SME exemption to fast-growing SMEs. The option meets almost all the policy objectives and is fully compatible with the general results of the stakeholder consultations.

**Option 4.** The proposed VAT treatment for occasional traders leads to an overall reduction in compliance costs for businesses of 17% compared to the baseline<sup>166</sup> and a positive impact on the administrative burden of tax authorities, due to a reduced number of small taxpayers to control. The option is also expected to have a positive impact on compliance by reducing voluntary VAT registrations and related input VAT fraud risk. About 6.4 million businesses are estimated to be impacted by this option, 60% of which are already exempt from VAT under the SME exemption. Consequently, the impact on revenues is expected to be very small and even positive as the option eliminates the risk of excessive VAT input deductions. Although all the policy objectives are met under Option 4, this option is not favoured, as explained in section 7.3 below, due to the fact that it would require legislative changes which could not be encompassed in this exercise, and also given the negative feedback from stakeholders received during the Fiscalis 2020 Workshop in March 2017. It should be mentioned that Option 4 was not discarded from the very beginning of the impact assessment process, but was given serious consideration. The conclusion that this option cannot be the preferred one was reached only after a thorough assessment of its legal and economic implications.

The table below analyses and evaluates the various impacts across the 4 options.

**Table 12: Summary analysis of impacts**

Key impacts	Option 1	Option 2	Option 3	Option 4
<b>A – Efficiency</b>				
<b>Impact on Member States</b>				
Member States’ revenues from intra-EU trade	=	-	-/+	-/+
Administrative burden	=	-	++	+++
Compliance and fraud	=	--	++	+++
<b>Impact on businesses</b>				
VAT compliance costs	=	++	+++	+++
<b>Impact on wider economy</b>				
Effects on output of impacted SMEs	=	++	+++	+++
Effects on SMEs intra-EU trade	=	++	+++	+++
Effects on prices and consumers demand	=	+	+	++
<b>B – Effectiveness of options vs policy objectives</b>				
Reducing VAT compliance costs for SMEs	=	++	+++	+++
Reducing distortions for SMEs	=	+++	+++	+++
Facilitate compliance and monitoring	=	+	+++	+++
Reducing the negative impact of the threshold effect	=	+	+++	+++
Reducing revenue losses caused by occasional traders	=			+++

<sup>166</sup> Option 4 leads to an additional reduction in compliance costs of EUR 2.1 billion compared of the medium simplification scenario of Option 2).

Key impacts	Option 1	Option 2	Option 3	Option 4
<b>C – Coherence</b>				
e-commerce proposal	=	+++	+++	+++
Future initiatives (rates, definitive VAT system, administrative cooperation)	=	+	+++	+++
<b>D – Key indicators</b>				
VAT Revenues (EUR)		-665 mn	-2 660 mn	-2 660 mn
VAT Revenues (%)		-0.06%	-0.24%	-0.24%
Business Compliance Costs (EUR)	68 bn	58.6 bn (decrease of 9.4 bn)	56.1 bn (decrease of 11.9 bn)	56.5 bn (decrease of 11.5 bn)
Business Compliance <sup>167</sup> Costs (%)		-14%	-18%	-17%
Overall assessment	Does not meet objectives	<b>Partially meets objectives</b>	<b>Meets objectives to a large extent</b>	<b>Fully meets objectives</b>

#### Legend

+++ much better suited	++ better suited	+ slightly better suited
= no difference		
- less suited	-- slightly less suited	--- much less suited

Source: Commission services

## 7.2. Identification of the preferred option

**Options 2 to 4** respond to the general objectives identified in this Impact Assessment based on the EU policy priorities and in particular, they fulfil, although to a different level, the key objective of reducing the compliance costs for SMEs.

Overall, due to the gradual construction, **Option 4** is the only option that meets all the specific objectives, representing the full package of measures. **However, this option is not favoured because it would require legislative changes touching upon complex VAT issues that need a distinct evaluation exercise. Moreover, this option was not supported by Member States and other stakeholders (see section 7.3).**

Regarding the reduction of distortions between domestic SMEs and SMEs trading cross-border, **Options 2 to 4** have an equally positive impact, as they allow suppliers from other Member States to benefit from the SME exemption available in other Member States.

For the reduction of VAT compliance costs for businesses, **Option 3** is expected to achieve the highest positive impact compared to the baseline scenario. This is due to the introduction of a transitional period for SMEs exceeding the VAT exemption threshold. **Option 4** also meets positively this objective, but with a slightly minor effect. Also **Option 3** includes the positive impact on compliance costs resulting from the simplification measures introduced under **Option 2**.

The combined objective of facilitating compliance and monitoring is most positively met by **Option 3** as the transitional period gives businesses time to become acquainted with the normal VAT scheme, and this encourages voluntary compliance. **Option 4** also meets this objective since occasional traders do not need to register or account for VAT. **Option 2**, as such, is expected to have a limited positive impact on compliance control by tax authorities, since opening up the SME exemption to businesses from other Member States will increase the complexity of the scheme.

<sup>167</sup> The estimations are based on the set of VAT obligations under the medium simplification scenario of Option 2.

Regarding the objective of reducing the negative impact of the threshold effect **Option 3** has the most positive impact since it is specifically designed to facilitate SMEs in their transition from being VAT exempt to having to comply with the full set of VAT obligations. **Option 2** does not meet this objective. **Option 4** does so because it builds on **Option 3**.

**Option 4** is the only option that meets the specific objective to reduce revenue losses caused by occasional traders by taking them out of the VAT system. However, this option was considered untenable for several reasons explained in the following section 7.3.

**The analysis above indicates that Option 3 is the most effective in meeting the policy objectives as well as in following the overall orientation expressed by the stakeholders. For that reason it is the preferred option.**

### **7.3. VAT treatment of occasional traders: option not favoured**

Although Option 4 (earlier identified in the Inception Impact Assessment) is the only option that meets all the specific objectives of the initiative, this option is not the favoured one in the context of this exercise. The choice is justified by several reasons.

Firstly, the implementation of this option would require legislative changes touching upon complex VAT issues such as the scope of VAT. Notably, it would be necessary to define the concept of occasional traders and its relationship with Articles 9 and 12 of the VAT Directive, which currently determine the notion of taxable person.

Secondly, even though the proposal to treat the occasional traders as non-taxable persons were beneficial in terms of revenues saving and reduction of administrative burden, Option 4 could bring a potential negative impact on the level playing field towards businesses (including the small ones) providing the same services as the occasional traders<sup>168</sup>.

Finally, given the dynamic character of new business models and the rapid growth of digital technologies, it is difficult to foresee the developments of the economic activities and the impact that these developments might have on traders' and consumers' behaviour. Further policy issues may then emerge that need to be addressed. The option was considered untenable as further analysis is indeed necessary to have a comprehensive understanding of the matter.

In addition, it must be noted that **Option 4** did not receive support from Member States and businesses during the public consultation<sup>169</sup>. In particular, a legislative intervention was not considered the best way forward by the stakeholders, who rather recommended to tackle the subject in the VAT Committee before assessing the need for further action in this sensitive area. The choice to take out Option 4 is actually broadly compatible with the results of the open public consultation, in which 57% of respondents concluded that occasional traders should remain subject to the VAT system. In this regard, the estimates confirm that 60% of the identified occasional traders are businesses already exempt from VAT under domestic schemes for small businesses.

---

<sup>168</sup> However, to estimate the impacts of Option 4, it has been assumed that the economic activity carried out by the occasional traders does not create distortions of competition and the amount of VAT potentially collected is negligible.

<sup>169</sup> See Annex 2.

It is important to note that the treatment of occasional traders will be taken up by other initiatives on the digital economy with a wider scope. As regards the sharing economy, the VAT Committee has agreed on some guidelines, according to which individuals supplying goods and services through collaborative platforms may qualify as taxable persons for VAT purposes. Such individuals can therefore benefit from the SME exemption or opt for the application of normal VAT rules. Therefore, under the current legal framework, the assessment as to whether occasional traders act as taxable persons for VAT purposes is remitted to a case-by-case analysis by Member States.

#### **7.4. Subsidiarity of the preferred option**

The preferred Option 3 is considered to be consistent with the principle of subsidiarity as the main problems which have been identified (high compliance costs, distortive effects, etc.) are triggered by the rules of the existing VAT Directive. Given that VAT is an EU tax, Member States are currently not allowed to set different rules by themselves and therefore any initiative to simplify VAT rules and reduce the compliance burden for SMEs requires a proposal by the Commission to amend the VAT Directive. Therefore Option 3 will clearly offer value over and above what can be achieved at Member State level.

#### **7.5. Proportionality of the preferred option**

The preferred Option 3 is considered to be consistent with the principle of proportionality, i.e. it does not go beyond what is necessary to meet the objectives of the Treaties, in particular the smooth functioning of the Single Market. As follows from the subsidiarity test, it is not possible for Member States to address the problems and problem drivers without a proposal to amend the VAT Directive.

The following aspects have been taken into account in assessing the proportionality:

- There is an **overall reduction in the compliance costs** businesses face when trading in the Single Market, with Option 3 providing the highest reduction in costs.
- SMEs will benefit from a **more level playing field** since businesses will be able to benefit from the SME exemption available in other Member States.
- There is an **alignment between different national practises, by introducing a common minimum set of simplification measures** for both exempt and non-exempt SMEs.
- The proposed SME exemption will be **optional for businesses and Member States**. Further, a level of flexibility is given to Member States to adapt the scheme and the simplification measures to the characteristics of their domestic markets.
- The introduction of an SME turnover threshold generated EU-wide keeps the new **SME exemption targeted at SMEs and limits the risk of reverse distortions**.
- The **negative impact on VAT revenue is very low** given the small proportion of VAT revenue generated by SMEs. Further, in the longer term the revenue impact is expected to be positive, due to the general positive effect on the SMEs' outputs.
- The preferred option is **coherent with the destination principle**.

#### **7.6. Impact on SMEs**

To assess the impact of the various options on SMEs as compared to the *status quo* has been a central objective of this Impact Assessment.

Hence, specific measures have been undertaken to involve small enterprises during the work leading to the adoption of this proposal. In particular, we have sought feedback (in quantitative and qualitative terms) from SMEs in order to understand the issues that they face, and we have also got their views on possible changes as regards such provisions. In particular, the consultation activities targeting SMEs were<sup>170</sup>:

- 1) The **2017 Deloitte SME study**, which involved gathering the views of SMEs on the current VAT provisions for SMEs and their application, as well as on possible changes as regards these provisions.
- 2) An **SME panel consultation** was specifically directed at SMEs in coordination with representative groups.
- 3) In evaluating the current system and considering the options for review, the Commission ensured that SMEs were represented at the **Fiscalis 2020 Wroclaw Workshop**.

The analysis of the impacts of the preferred policy option on SMEs relies, in particular, on the 2017 Deloitte SME study. This study was focused on SMEs with annual turnover not exceeding EUR 2 000 000. For the impact analysis a specific sub-set of SMEs that are likely to be directly impacted by the policy options was identified. These businesses are those with an annual turnover below the threshold of EUR 100 000. However, also SMEs with the annual turnover exceeding the exemption threshold and not exceeding EUR 2 000 000 will be impacted through aligned simplified VAT obligations. The latter impact is, however, difficult to quantify as it depends on the very details of the simplification package proposed which is being defined on the basis of the 2017 Deloitte SME study itself, public consultation, consultation with the Member States and the Commission's experience relating to VAT obligations.

The benefits of the preferred Option 3 for SMEs can be summarised as follows:

- The overall **compliance costs** that SMEs face to comply with VAT obligations are reduced by 18% (or EUR 56.1 billion) per year.
- SMEs engaged in **cross-border trade** could benefit from the **SME exemption available in the Member States of destination**.
- The improvement of **competitiveness for SMEs** will allow them to increase their economic activity by over 16% per year<sup>171</sup>.
- **Fast growing SMEs** that exceed the exemption threshold will continue to benefit for a transitional period from the SME exemption in order to be prepared for the standard VAT regime, thus **limiting the negative threshold effect**.
- **Aligned simplification measures** among Member States (streamlined simplification package) will **reduce the costs of cross-border activities**.
- The review will bring **more clarity overall and legal certainty** for both small enterprises and national administrations.

## 7.7. Impact from the REFIT perspective

This initiative is part of the REFIT<sup>172</sup> programme. Such programme is devoted to making EU law simple and less costly, in particular for small enterprises, which can be disproportionately affected by the burden of implementing EU rules.

---

<sup>170</sup> For more information on the consultation strategy, see Annex 2.

<sup>171</sup> 2017 Deloitte SME study, Volume I, p. 187.

<sup>172</sup> For more general information on the REFIT programme, see section 1.2.

According to the Commission Work Programme<sup>173</sup> laying down the new initiatives to be adopted under the REFIT programme during 2017, the SME review will be adopted in the framework of the Commission's priority<sup>174</sup> 'A Deeper and Fairer Internal Market with a Strengthened Industrial Base'. As laid down in this 2017 Programme, the Commission is cognisant of the fact that the compliance burden for small businesses derived from VAT is high and that technical innovations pose new challenges for effective tax collection; hence, it committed to bring forward measures to implement the VAT Action Plan and, in particular, to **simplify VAT for smaller companies** and set the foundations for a modern, more efficient, business-friendly and fraud-proof definitive VAT regime across Europe.

Therefore, the REFIT-related objectives of this proposal are: (i) to reduce the VAT burdens for small businesses and tax administrations, and (ii) to reduce distortions at EU level, with a view to encourage SMEs to fully profit from the Single Market.

The preferred Option 3 delivers on both of the REFIT objectives. Its benefits are summarised in the above section 7.5. See Annex 2 for a summary of the main contributions received via the REFIT platform.

## 8. HOW WOULD ACTUAL IMPACTS BE MONITORED AND EVALUATED?

The Commission and Member States shall monitor and evaluate the functioning of this initiative and the extent to which its objectives<sup>175</sup> have been attained.

To that end, Member States shall communicate to the Commission any relevant information necessary for the evaluation of the effectiveness, efficiency, coherence with other interventions with similar objectives, and continued relevance of the Directive that this Impact Assessment accompanies. Moreover, a set of indicators must be established in respect of each of the policy objectives of the preferred option, as presented below. On the basis of such information, the Commission will prepare a retrospective evaluation of the functioning of that Directive five years after its entry into force.

The implementation of the proposal as such (i.e. transposition of the legal provisions foreseen in the preferred option into the national laws of Member States) will be monitored as part of the responsibilities of the Commission for ensuring that EU VAT legislation is correctly applied.

- *Objective 1: Reduction of compliance costs*

The objectives of the initiative linked to reducing VAT compliance costs for SMEs, both domestically and at EU level, will be monitored by reference to compliance costs for SMEs trading domestically only and for SMEs trading cross-border.

---

<sup>173</sup> Annex 1 to the Communication from the Commission to the European Parliament, the Council, the European Economic and Social Committee and the Committee of the Regions – Commission Work Programme 2017 ([COM\(2016\) 710 final](#)), p. 3.

<sup>174</sup> Communication from the Commission to the European Parliament, the Council, the European Economic and Social Committee and the Committee of the Regions – Commission Work Programme 2017 ([COM\(2016\) 710 final](#)), p. 8-9 (priority number 4). The Commission's priorities are outlined in the [Political Guidelines](#) presented at the start of the Commission's mandate.

<sup>175</sup> Although reference is made to objectives in general, this section sets out how to monitor the specific objectives (set out in section 4.2) which are linked to the preferred policy option (Option 3).

Such compliance costs will have to be estimated<sup>176</sup> after the implementation of the proposal, but it is difficult to determine at this point which data sources could be used. Although it may be necessary to carry out an ad-hoc exercise, given that updated data on compliance costs is not easily available, less costly alternatives will be considered. For instance, it may be possible to combine the monitoring of similar policy objectives (i.e. reduction of compliance costs) of different VAT-related proposals, which would minimise the data-collection burden and the overlap of available evidence. In this respect, the e-Commerce proposal envisages to monitor the cost savings for businesses trading cross-border via a standard cost model exercise which should be carried out 3 years after the implementation of that proposal<sup>177</sup>.

Data on compliance costs will also rely on the Annual Burden Survey carried out by the European Commission, although the level of detail may not be specific for small enterprises; data provided by Member States; as well as feedback received from the EUROFISC network<sup>178</sup>, the Standing Committee on Administrative Cooperation (SCAC)<sup>179</sup>, and relevant stakeholders.

- *Objective 2: Reduction of distortions (more level playing field for SMEs)*

The reduction of distortions at domestic level aims at treating equally SMEs under the SME exemption and businesses which are not under the exemption but still qualify as small enterprises, by means of reducing the compliance burden of the latter. Therefore, this objective will be monitored via the compliance costs<sup>180</sup> of SMEs trading domestically only under the exemption, and those of SMEs trading domestically only but not covered by the exemption.

Another objective of the proposal is to reduce obstacles to cross-border trade. This objective will be monitored by reference to three indicators: (i) compliance costs<sup>181</sup> for SMEs trading domestically only and for SMEs trading cross-border; (ii) number of non-established small enterprises registered in a Member State for VAT purposes; and (iii) number of non-established small enterprises benefitting from the SME exemption in a Member State. Data about non-established businesses will be obtained from Member States.

The latter indicator, linked to the opening up of the SME exemption, is a direct result of the implementation of the proposal. As regards the number of non-established SMEs registered in a Member State, a comparison will have to be made between the figures before and after the implementation of the new rules, and its assessment will have to take into account the possibility of data being dependent on other factors (e.g. the economic context).

---

<sup>176</sup> E.g. based on the Standard Cost Model (SCM) method, also used in the 2017 Deloitte SME study.

<sup>177</sup> See Commission Staff Working Document: Impact Assessment, accompanying the Proposals for a Council Directive, a Council Implementing Regulation and a Council Regulation on Modernising VAT for cross-border B2C e-Commerce ([SWD\(2016\) 379 final](#)), p. 52. It will also be considered whether the estimation of compliance costs can be inferred from other available studies or reports (e.g. the Annual Burden Survey, to be published by the Commission).

<sup>178</sup> EUROFISC is a mechanism provided for Member States to enhance their administrative cooperation in combating organised VAT fraud. For more information, see [here](#) and Council Regulation 904/2010 on administrative cooperation and combating VAT fraud ([OJ L 268 of 12.10.2010, p. 1](#))

<sup>179</sup> SCAC is an expert group in the field of VAT – administrative cooperation, which brings together TAXUD officials and representatives of all Member States. For more information, see [here](#).

<sup>180</sup> Estimated, as outlined under '*Objective 1: Reduction of compliance costs*'.

<sup>181</sup> *Ibid.*



- *Objective 3: Reduce the negative impact of the threshold effect (more level playing field for SMEs)*

The attenuation of the threshold effect will be monitored by reference to the number of SMEs making use of the transitional measures available under certain circumstances where the SME exemption threshold is exceeded. Such information will have to be reported by Member States.

- *Objective 4: Facilitate compliance for businesses and monitoring by tax administrations (fight against the VAT fraud)*

The objective to reduce VAT revenue losses derived from non-compliance will be monitored via the following indicators: (i) the VAT gap, which measures how much VAT Member States are losing<sup>182</sup>; and (ii) compliance costs for SMEs<sup>183</sup>. The VAT gap will be based on the VAT gap study carried out periodically by the Commission in close collaboration with Member States.

It must be acknowledged that the VAT gap can be influenced by several factors (e.g. fraud or tax avoidance, or bankruptcies) other than non-compliance or miscalculations due to the complexity of the VAT System. However, the VAT gap is an indicator commonly accepted as a proxy for measuring the effectiveness of VAT enforcement and compliance, which will also be put into perspective thanks to the estimation of compliance costs for SMEs.

The table below summarises the indicators that will be used for monitoring whether the policy objectives of the preferred option (Option 3) have been attained, how such indicators will be measured, as well as the operational objectives.

**Table 13: Monitoring and evaluation framework**

Objectives preferred option	Indicators	Measurement of the indicators	Operational objectives
1) To reduce VAT compliance costs for SMEs at two levels, domestically and within the EU:			
<ul style="list-style-type: none"> <li>• Compliance costs for domestic SMEs, derived from complex national VAT rules</li> </ul>	<ul style="list-style-type: none"> <li>• Compliance costs for SMEs trading domestically only, and for SMEs trading cross-border</li> </ul>	<ul style="list-style-type: none"> <li>• Estimation of compliance costs to be carried out after implementation</li> </ul>	<ul style="list-style-type: none"> <li>• Reduction of compliance costs of SMEs trading domestically only (target: reduction by 3%)</li> </ul>
<ul style="list-style-type: none"> <li>• Compliance costs for SMEs trading cross-border, derived from the diversity of VAT rules across the EU</li> </ul>			<ul style="list-style-type: none"> <li>• Reduction of compliance costs of SMEs trading cross-border (target: reduction by 5%)</li> </ul>
2) To reduce distortions at two levels, domestically and within the EU:			

<sup>182</sup> The VAT gap is based on the actual VAT receipts compared to the theoretical amount of VAT that should be collected based on domestic consumption. For more information, see [here](#).

<sup>183</sup> Estimated, as outlined under ‘Objective 1: Reduction of compliance costs’.

<ul style="list-style-type: none"> <li>Distortions between domestic SMEs under the exemption and domestic SMEs that do not qualify for the exemption</li> </ul>	<ul style="list-style-type: none"> <li>Compliance costs for SMEs trading domestically only covered by the exemption, and for SMEs trading domestically only under normal VAT rules</li> </ul>	<ul style="list-style-type: none"> <li>Estimation of compliance costs to be carried out after implementation</li> </ul>	<ul style="list-style-type: none"> <li>Reduction of compliance costs of SMEs trading domestically only under normal VAT rules (target: reduction by 3%)</li> </ul>
<ul style="list-style-type: none"> <li>Distortions between domestic suppliers and suppliers established in other Member States</li> </ul>	<ul style="list-style-type: none"> <li>Cross-border activity of SMEs (percentage of the total value of cross-border trade).</li> </ul>	<ul style="list-style-type: none"> <li>Reporting from Member States</li> <li>Feedback provided by businesses</li> </ul>	<ul style="list-style-type: none"> <li>Increase in the cross-border activity of SMEs (target: increase by 13%)</li> </ul>
	<ul style="list-style-type: none"> <li>Number of SMEs benefitting from the SME exemption in a Member State other than the one where they are established</li> </ul>	<ul style="list-style-type: none"> <li>Reporting from Member States</li> </ul>	<ul style="list-style-type: none"> <li>Use of the SME exemption by SMEs in a Member State other than the one where they are established (target: 500 000 businesses per year at EU level)</li> </ul>
	<ul style="list-style-type: none"> <li>Compliance costs for SMEs trading domestically only, and for SMEs trading cross-border</li> </ul>	<ul style="list-style-type: none"> <li>Estimation of compliance costs to be carried out after implementation</li> </ul>	<ul style="list-style-type: none"> <li>Reduction of compliance costs of SMEs trading domestically only (target: reduction by 3%); and reduction of compliance costs of SMEs trading cross-border (target: reduction by 5%)</li> </ul>
<p>3) To reduce the negative impact of the threshold effect</p>	<ul style="list-style-type: none"> <li>Number of businesses making use of transitional measures</li> </ul>	<ul style="list-style-type: none"> <li>Reporting from Member States</li> </ul>	<ul style="list-style-type: none"> <li>Use of the transitional measures by SMEs (target: 260 000 businesses per year at EU level)</li> </ul>
<p>4) To facilitate compliance by SMEs and the monitoring by tax administrations</p>	<ul style="list-style-type: none"> <li>Evolution of VAT gap</li> </ul>	<ul style="list-style-type: none"> <li>Periodic VAT gap study by the Commission</li> </ul>	<ul style="list-style-type: none"> <li>Positive trend in the VAT gap (target: EU average lower than 14%)</li> </ul>
	<ul style="list-style-type: none"> <li>Evolution of compliance costs for SMEs</li> </ul>	<ul style="list-style-type: none"> <li>Estimation of compliance costs to be carried out after implementation</li> </ul>	<ul style="list-style-type: none"> <li>Reduction of compliance costs for SMEs (target: reduction by 3%)</li> </ul>

Source: Commission services

## 9. ANNEXES

In addition to the obligatory Annexes, eight further Annexes are attached.

### **Obligatory Annexes:**

1. Procedural information
2. Stakeholder consultation
3. Who is affected by the initiative and how
4. Analytical models used in preparing the impact assessment

### **Additional Annexes:**

5. Measures for SMEs available in the VAT Directive
6. Interplay among the proposals on the destination principle
7. Functioning of Option 2 in an intra-EU context
8. Evaluation of the current VAT system for SMEs
9. SME exemption thresholds in the EU
10. Special VAT SME measures applied in Member States
11. VAT obligations linked to the SME exemption per Member State
12. Enterprise Europe Network – SME feedback database

## **ANNEX 1: PROCEDURAL INFORMATION**

### **1. AGENDA PLANNING AND WORK PROGRAMME REFERENCES**

The Commission announced the preparation of the comprehensive simplification package for SMEs in the 2015 Single Market Communication and confirmed it in the 2016 VAT Action Plan. The review was also mentioned in the 2016 Start-Up Communication.

Prior to that, the Commission had already pledged to the ‘think small first’ principle in the 2008 SBA Communication, and had also advocated for simplifying the regulatory and administrative environment in which SMEs operate in the 2011 Communication on the Future of VAT.

DG TAXUD is the lead Directorate-general for the initiative. The Agenda Planning Reference is 2017/TAXUD/008. The [Inception Impact Assessment](#) was published in December 2016.

### **2. INTER-SERVICE STEERING GROUP**

An Inter-Service Steering Group was set up in 2015. In total, six meetings were organised on 7 December 2015, 22 January 2016, 8 June 2016, 5 December 2016, 7 April 2017 and 30 June 2017. The meetings were chaired by the SG.

The following directorates and services were consulted: DG AGRI, DG BUDG, DG CONNECT, DG COMP, DG ENER, DG ENV, DG FISMA, DG GROW, DG JUST, OLAF, SG and SJ. The feedback received from these directorates and services has been taken into account in the Impact Assessment.

### **3. CONSULTATION OF THE REGULATORY SCRUTINY BOARD**

The Regulatory Scrutiny Board was consulted on 13 September 2017. On 15 September 2017, the Board gave a positive opinion on the report. The recommendations made by the Board to further improve the report were taken into account. The main changes introduced concern the following aspects:

- Clarification of how the definitive VAT regime changes the context compared to earlier attempts to simplify the SME regime, and how this affects SMEs (section 1.2);
- Further explanations regarding the contents of policy options and explanation why the full harmonisation option is discarded (section 5);
- Clarification of why the objective and the option relating to occasional traders are ultimately discarded (sections 7.1 and 7.3).

Further specific changes were also made in the report in order to take account of more technical recommendations made by the Board. These relate, in particular, to:

- Developed setting of the context for the proposal ( section 1.2);
- Clarification of the scope of the review and options (section 5);
- Clarification of the elements taken up in the proposal (in particular – section 5.2.2.);
- Further explanation of simplification elements (section 5.2.2.);
- Monitoring (section 8);
- Stakeholder views, including the elements raised in the REFIT Platform opinion (section 2.5, section 5.2.2., Annex 2).

#### 4. STUDIES TO SUPPORT THE IMPACT ASSESSMENT

The Commission engaged Deloitte as consultants to:

- 1) Assess the functioning of the SME scheme(s) at the level of the Member States and at the level of the EU as a whole,
- 2) Develop options for the review of the provisions of the VAT Directive on the SME scheme,
- 3) Prepare an analysis of benefits and costs, opportunities and risks in respect of the options considered for this review, with the expectation that the analysis will feed into preparations for a future legislative proposal on the SME scheme.

In addition, the impact assessment benefitted from:

- Institute for Fiscal Studies (IFS) and others, *A retrospective evaluation of elements of the EU VAT system*, 2011. Available [here](#).
- Deloitte, *VAT Aspects of cross-border e-commerce – Options for modernisation*, Final report, 2015-2016. Available [here](#).
- the on-going studies on:
  - Literature review on taxation, entrepreneurship and collaborative economy carried out by Dondena and
  - Tax compliance costs for SMEs carried out by KPMG.
- OECD, *Taxation of SMEs in OECD and G20 Countries*, 2015. Available [here](#).

## ANNEX 2: STAKEHOLDER CONSULTATION

### 1. CONSULTATION STRATEGY

The consultation strategy of this legislative initiative had two main purposes. The first was to receive feedback from stakeholders on the application of the current VAT provisions for SMEs, and the second was to get their views on possible changes as regards such provisions. The strategy consisted of five main consultation activities, whose characteristics are outlined below.

**Table 14: Overview of the consultation activities**

Consultation activity	Type	When	Stakeholders consulted				
			Businesses (SMEs in particular)	Business associations <sup>184</sup>	Member States	Academics	Members of the public
1) Consultation undertaken by Deloitte as part of the SME study	Targeted	January – August 2016	✓	✓	✓		
2) SME panel consultation (Enterprise Europe Network)	Targeted	May – June 2016	✓	✓			
3) Open public consultation	Open	December 2016 – March 2017	✓	✓	✓	✓	✓
4) Fiscalis 2020 workshop (Wroclaw, Poland)	Targeted	March 2017	✓	✓	✓	✓	
5) Contributions received via the REFIT platform	Targeted	Since 2015	✓	✓			

Source: Commission services

In designing the consultation strategy, the Commission was conscious of the need to gather direct feedback from SMEs and Member States, the most relevant stakeholders of this initiative, in addition to dialogues with other stakeholders such as business associations, tax practitioners and academics; and also of the fact that it may be difficult to engage SMEs due to their limited time and human resources. Hence, several efforts have been made in particular to reach out to and invite SMEs to participate in the public consultation activities carried out, and to ensure that their views are duly reflected in the outcome of such consultations.

Firstly, the Commission requested the consultation undertaken by Deloitte as part of the study to specifically target small enterprises. This is why the data sources include, among others, a survey carried out with 500 SMEs in four representative markets; in-depth interviews with small enterprises to gather qualitative information on the functioning of the SME scheme; and also a workshop with, among others, SME organisations. Secondly, the consultation strategy included an SME panel consultation conducted through Enterprise Europe Network, an organisation only targeting SMEs. Thirdly, the open public consultation, which was foreseen as an opportunity to

<sup>184</sup> Including tax practitioners.

get direct feedback from small enterprises which are not members of any representative organisation, was available in all 23 official EU languages to avoid linguistic barriers precluding SMEs from participating. And fourthly, the workshop held within the Fiscalis 2020 Programme, which usually involves Member States only, was organised in the form of a joint meeting of the Group on the Future of VAT ('GFV') and the VAT Expert Group ('VEG') to allow business organisations which are VEG members to participate.

Finally, it should be pointed out that outside the framework of the above consultation activities, several valuable spontaneous contributions have been delivered, in particular the one of UEAPME – the European SME umbrella organisation, representing about 12 million enterprises<sup>185</sup>, reflected also in its position paper on the SME scheme, published in June 2017<sup>186</sup>.

## **2. SUMMARY OF THE CONSULTATION ACTIVITIES AND THEIR RESULTS**

A summary of the consultation activities and their results is presented below.

### **2.1. Consultation undertaken by Deloitte as part of the SME study**

A targeted consultation of stakeholders took place as part of the 2017 Deloitte SME study between January and August 2016. This process, which aimed at gathering the views of stakeholders on the current VAT provisions for SMEs and their application, as well as on possible changes as regards these provisions, mainly involved:

- 1) A survey sent to all 28 Member States' tax authorities to collect quantitative data on, among others, the number of SMEs within each turnover bracket as defined in the study in their Member State, as well as data related to the application of the special schemes applied.
- 2) A survey also completed by VAT experts (Deloitte Network) in all 28 Member States with regard to more qualitative elements of the measures for SMEs provided for in the VAT Directive, including their functioning.
- 3) Surveys carried out by the company 'Ipsos Mori' in four markets, Austria, Italy, Poland and the UK. Interviews were made with 500 SMEs in each country, and businesses were asked about their turnover, their VAT obligations and cross-border trading behaviours.
- 4) In-depth interviews with SMEs and accountants in eight selected Member States: Belgium, Estonia, France, Italy, Poland, Romania, Spain and the UK.
- 5) Finally, a workshop was held on 15 March 2016 with Commission representatives and several business organisations for defining the current problems and potential policy objectives. Some of such organisations were SME-specific, such as the European Small Business Alliance ('ESBA'), the European Association of Craft, Small and Medium-sized Enterprises ('UEAPME'), and the European Confederation of Junior Enterprises ('JADE').

---

<sup>185</sup> See UEAPME's website at <http://www.ueapme.com/>.

<sup>186</sup> See [http://www.ueapme.com/IMG/pdf/UEAPME\\_position\\_paper\\_on\\_VAT\\_SME\\_Scheme.pdf](http://www.ueapme.com/IMG/pdf/UEAPME_position_paper_on_VAT_SME_Scheme.pdf).

The findings derived from the activities above have been integrated into the Deloitte study<sup>187</sup>, which will be publicly available on the DG TAXUD [website](#) by the end of 2017. Some key elements are presented below.

- SMEs represent a majority of active businesses in the EU, and this is consistent across Member States. However, despite representing around 98% of businesses, they only generate 15% of turnover and 25% of net VAT revenues. This difference is even more striking for the smallest businesses: those with less than EUR 50 000 of turnover represent about 69% of all businesses, but generate less than 1% of the EU-wide turnover.
- VAT reporting is perceived as one of the most burdensome VAT obligations in general, and particularly so for SMEs. VAT registration was also highlighted as a burdensome obligation, especially for non-established businesses.
- The SME flat rate scheme is not implemented broadly: only eight Member States currently make use of this scheme. The flat rate scheme is perceived as prone to fraud in some Member States and the tendency with tax authorities is to move away from this kind of scheme.
- The SME exemption has the highest implementation rate among Member States and also a very high participation rate among eligible businesses (based on Deloitte estimations, the average EU take-up rate is of 63%).
- The SME graduated relief scheme is not widely implemented across the EU and indeed only three Member States currently apply this. Also, it does not seem to be largely used by eligible businesses in the Member States where it is available<sup>188</sup>.
- SMEs (whether they benefit or not from VAT special schemes) depend to a very large extent on the support of accountants and business organisations providing fiscal services to comply with fiscal obligations on VAT.
- Tax authorities are moving towards automating administrative tasks (including VAT-related obligations), as a way to streamline and simplify compliance.

## **2.2. SME panel consultation**

An SME panel consultation was conducted through the Enterprise Europe Network<sup>189</sup> ('EEN') during 9 weeks, from 2 May to 30 June 2016, using the EU survey tool. That network is managed by DG GROW and enables the Commission services to reach SMEs in a targeted way, as network partners in Member States are well placed in their regions to identify companies that

---

<sup>187</sup> See in particular 2017 Deloitte SME study, Volume I, sections 3 and 4 and the corresponding Annexes.

<sup>188</sup> In Spain for example, the scheme is generally considered to be an effective measure, although it may not provide the same full effect as the SME exemption. In contrast, in Finland the scheme has complicated rules and therefore is not widely used.

<sup>189</sup> The [Enterprise Europe Network](#) helps businesses innovate and grow on an international scale, and it is the world's largest support network for SMEs.



will be most affected by the subject of consultation. The consultation mainly aimed at gathering the views of SMEs on the current VAT provisions for SMEs and their application.

### Results of the SME panel consultation

Some key findings of the consultation are presented below.

#### *a) Profile of participants*

- The Commission received 1 704 replies to the survey. As regards the countries of origin of the enterprises participating in the survey, most replies were received from Portugal (almost 20% of all respondents). Companies from Poland and Germany represented, as regards both groups, above 10% of the respondents (respectively 17.2% and 10.2%). No replies to the questionnaire were transmitted from Croatia, Ireland, Malta, the Netherlands, Slovenia and Sweden. The only country outside the EU from which over 40 enterprises took part in the survey was the former Yugoslav Republic of Macedonia.
- Of the 1 704 replies received over 70% came from enterprises with a stated turnover up to EUR 2 000 000. One-third of all respondents were enterprises with a stated turnover not exceeding EUR 100 000.

#### *b) Application of the current VAT provisions for SMEs*

- More than half of respondents carry out sales to other Member States and almost 40% engage in supplies to markets outside the EU. Out of companies that do not sell goods or services outside their national markets only 9% indicated that the reason for this is linked to too complicated VAT obligations and only 7% referred to too high costs of complying with VAT obligations as to the reason for not carrying out supplies outside their national markets<sup>190</sup>.
- Close to 90% of enterprises that replied to the survey register for VAT domestically, file VAT returns and pay VAT. Above half of the respondents indicated that if it was not for VAT obligations, they would not keep records or would keep them in a simplified form. Close to half of the respondents said the same about invoicing.
- Almost one-third of the respondents consider complexity of VAT legislation as the main problem in ensuring compliance with VAT obligations. Above one-fifth indicate frequent changes in VAT legislation as problematic. As the most problematic VAT obligations almost 15% of respondents indicate filing VAT returns and over 12% deadlines for VAT payments.

---

<sup>190</sup> It should be noted that the outcome of the open public consultation closed in 2017 was quite different in this respect. See section 2.3.

**Figure 6: SME Panel results – most burdensome VAT obligations**

**Q12: Most burdensome VAT obligations for enterprises**

VAT obligation	Ranking	
Complexity of VAT legislation	1	(most burdensome)
Changes in VAT legislation	2	
VAT returns	3	
Deadlines for VAT payments	4	
Keeping records	5	
Handling of VAT payments	6	
Length of period keeping records	7	
Invoicing	8	
VAT recapitulative statements	9	
Domestic VAT registration	10	
Purchase lists	11	
VAT registration in other EU countries	12	
MOSS registration	13	(least burdensome)

Source: Commission services

- Only about 9% of respondents benefit from the SME exemption or a graduated relief. The simplification measures used the most by the respondents are standard deduction<sup>191</sup> (22% of respondents), annual recapitulative statements (EU sales lists – 14% of respondents), longer periods for paying VAT (14% of respondents), and simplified reporting (14% of respondents). Only a small group of respondents (7%) benefits from an SME flat-rate scheme.
- Respondents generally indicated the following as useful simplification measures: further simplified reporting (67% of respondents), simplified record keeping (65%), simplified invoicing (61%) and longer periods for paying VAT (56%). As the three most useful ones 27% of them ranked simplified record keeping, 23% still longer periods for paying VAT and 19% further simplified reporting.

### 2.3. Open public consultation

An Internet-based Open Public Consultation (‘OPC’) was held for 12 weeks from 20 December 2016 until 20 March 2017 using the EU survey tool. The consultation was available on DG TAXUD’s [website](#) in all 23 official languages to ensure that outreach was as broad as possible, and aimed at gathering the views of stakeholders on the current VAT provisions for SMEs and their application, as well as on possible changes as regards these provisions.

<sup>191</sup> Deduction of VAT based on a flat-rate. For more information on flat-rate schemes, see Annex 5.

## Results of the open public consultation

The input received from participants, as well as the full report on the results, is publicly available on DG TAXUD's [website](#). Some key findings of the OPC are presented below.

### *a) Profile of participants*

- The Commission received 113 submissions. The geographic coverage of the consultation was broad within the EU. The greatest number of submissions originated from Germany (35), followed by those from Belgium (18), the United Kingdom (8) and Portugal (6). It should be noted that the number for Belgium includes also submissions from the European business federations and associations which are based in Brussels.
- The majority of the respondents were businesses (46%), while business organisations and citizens represented respectively 30% and 7% of the participants. Moreover, three public authorities, four academics and a number of tax consultants responded to the public consultation.

**Figure 7: OPC results – distribution of respondents (by category)**

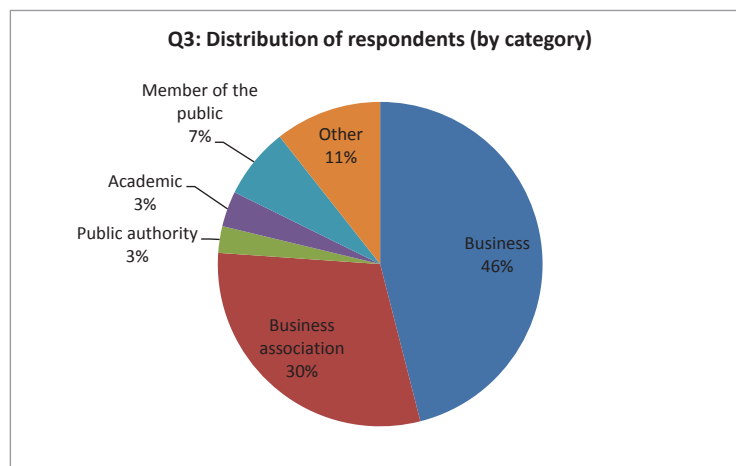

Source: Commission services

- Small enterprises were responsive to the consultation: the large majority of all the businesses which participated in the open public consultation had an annual turnover of below EUR 2 000 000 (80%); and, in particular, about 64% of them had an annual turnover not exceeding EUR 100 000.

### *b) Application of the current VAT provisions for SMEs (by business respondents only)*

- The SME exemption, applied by 27% of business respondents, is the provision laid down in the VAT Directive for SMEs used the most. However 57% of businesses participating in the consultation affirmed not to apply the SME exemption, mainly because their annual turnover exceeds the threshold. Some of these businesses also indicated that they are not interested in the SME exemption because they cannot deduct input VAT. Others simply replied that the scheme is not available in their Member State.

**Figure 8: OPC results – VAT provisions for SMEs currently applied**

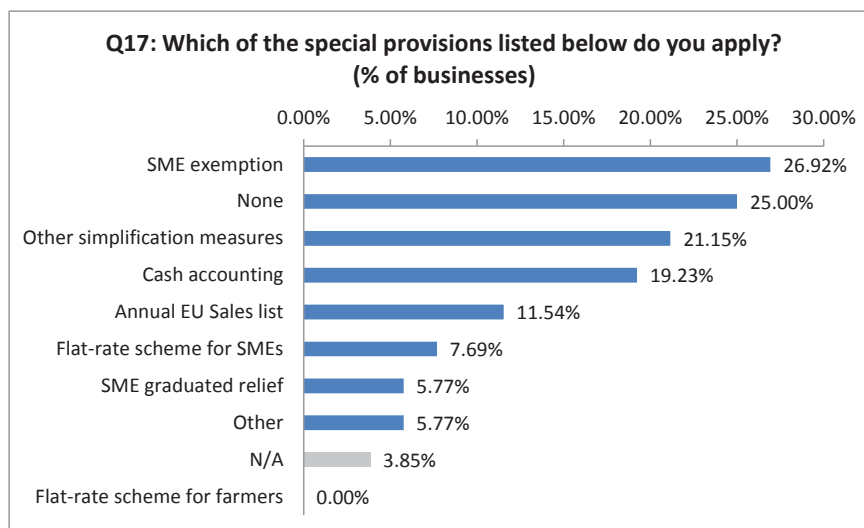

Source: Commission services

- The majority of participants in the consultation (54%) stated that the SME exemption could or should be improved. The main reasons for improvements were related to the fact that the exemption: (i) may have a distortive effect on competition, because it is currently only available to domestic SMEs; or (ii) can be detrimental to domestic SMEs not benefitting from the exemption compared to those who are exempted.
- Concerning the cross-border context, the vast majority of businesses (73%) and a number of other respondents affirmed that VAT obligations are important or very important in deciding whether to sell in other Member States.

**Figure 9: OPC results – weight of VAT obligations in deciding to sell cross-border**

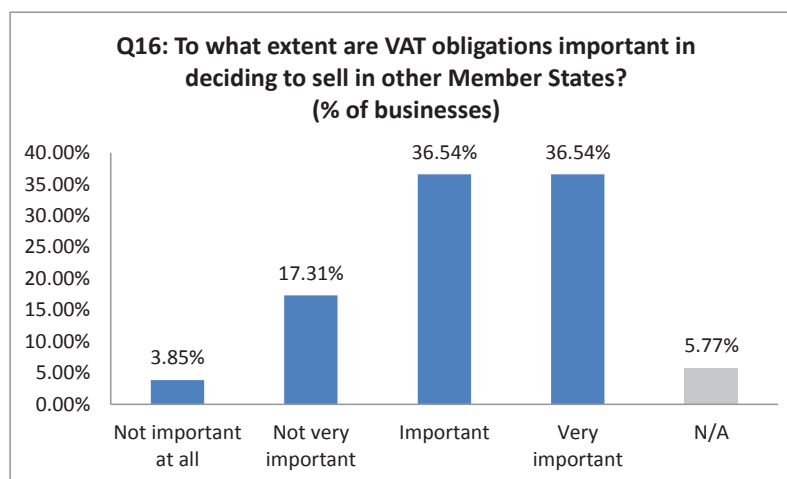

Source: Commission services

*c) Possible changes and improvements of the VAT provisions for SMEs*

- The large majority of all stakeholders (78%) indicated that there is still a need for an SME scheme in the VAT Directive aimed at alleviating the effects that SMEs are confronted with in dealing with VAT; and, particularly, an SME exemption (80%). The main argument in favour of an SME scheme resulting from the consultation was that

SMEs, particularly small and micro businesses, incur disproportionate compliance costs compared to large companies.

- When asked if the SME scheme should remain optional for both Member States and businesses, the majority of stakeholders, mainly self-employed and micro businesses, replied that the SME scheme should be mandatory for Member States (58%) but optional for businesses (65%).
- As regards the SME exemption, a majority of stakeholders (58%), mainly self-employed and micro businesses, but also a number of business associations, indicated that it should be mandatory for Member States to put in place instead of being optional.
- Moreover, a large majority of all stakeholders (71%) agreed or strongly agreed that the SME exemption, currently applied in different ways across the EU and with different thresholds, should be harmonised. However, some respondents advocated for some flexibility for Member States to set the threshold, given the different economic situation among Member States.
- A large majority of all stakeholders (79%) advocated that the SME exemption should be, fully or partially, available to all eligible enterprises within the EU. The most cited advantages of this change were the needs to encourage SMEs to fully seize the potential of the Single Market as well as to reduce the compliance costs of SMEs selling cross-border. On the other hand, a limited number of respondents indicated as main reason against the opening up of the SME exemption the increase of compliance and administrative costs for both SMEs and Member States, derived from increased audits and controls. They also mentioned a possible negative effect on Member States' revenues.

**Figure 10: OPC results – opening up of the SME exemption**

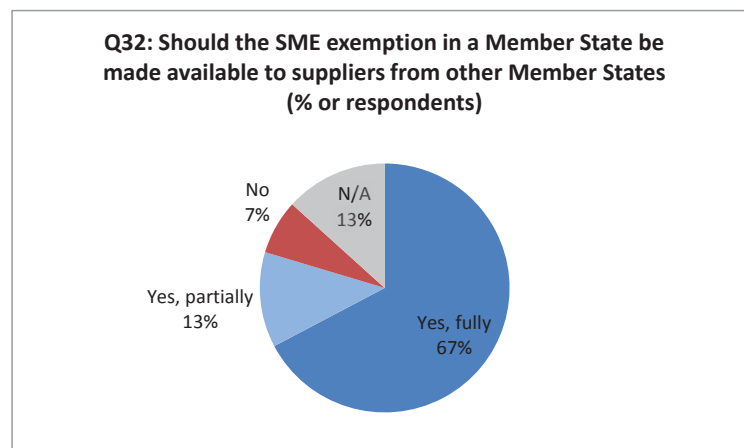

Source: Commission services

- Concerning the possibility to introduce a transitional measure to support SMEs to facilitate the transfer from exemption to full taxation, the vast majority of respondents (71%) agreed or strongly agreed that SMEs should be able to continue using the SME exemption for a short period, if their turnover exceeds the threshold temporarily.

- As regards the simplification measures, it results from the public consultation that there is a broad support (86% of respondents) for further simplification of VAT obligations for SMEs.

**Figure 11: OPC results – need to further simplify VAT obligations**

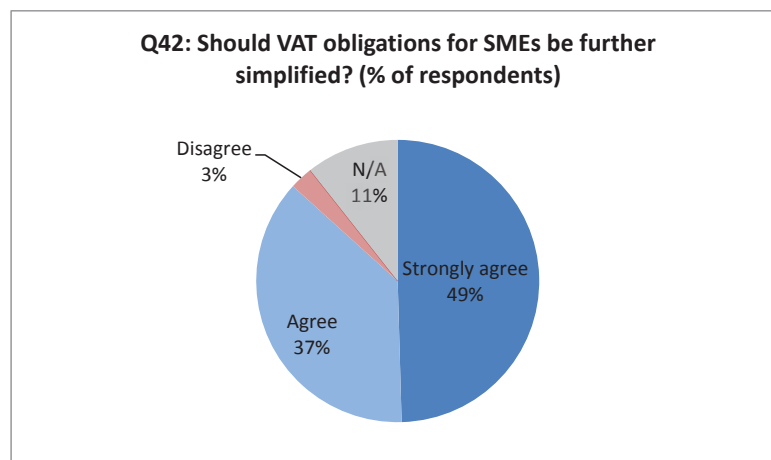

Source: Commission services

- The large majority of respondents (82%) agreed or strongly agreed that simplified VAT obligations should be available for all SMEs, irrespective of whether they use the SME exemption. It was also indicated by the majority (67%) that simplified VAT obligations should be mandatory for Member States instead of remaining optional.

## 2.4. Fiscalis 2020 Workshop

The Fiscalis 2020 Workshop was held in Wroclaw, Poland, during 3 days (20-22 March 2017) and brought together more than 90 participants, mainly representatives of the Member States in the Group on the Future of VAT (GFV)<sup>192</sup> and members of the VAT Expert Group (VEG)<sup>193</sup>, which are business organisations, VAT practitioners, and academics; and also Commission representatives. The Workshop included plenary sessions and work group discussions, the work groups being formed by a mix of participants from Member States and businesses. It aimed at gathering the views of stakeholders on the current VAT provisions for SMEs and their application, as well as on possible changes as regards these provisions.

### Results of the Fiscalis 2020 Workshop

Some key findings of the workshop are presented below.

- The original reasons for having in place a special VAT SME scheme – the reduction of compliance burden (from the point of view of businesses) and reduction of administrative costs (from the point of view of tax administrations) – were found valid.
- As regards registration, invoicing and filing of returns, there was little support for the introduction of measures specifically targeted at SMEs, and stakeholders stated that simplified VAT obligations should be available irrespective of the size of a company.

<sup>192</sup> For more information on the GFV, see [here](#).

<sup>193</sup> For more information on the VEG, see [here](#).

Businesses supported the idea of making some simplifications mandatory for Member States.

- The flat-rate scheme was considered to be a rather outdated measure. It could possibly be useful as a part of a more extensive package for businesses with specific characteristics. Harmonisation in this area was not necessarily found desirable.
- The SME exemption was in general perceived as a useful measure as it allows the reduction of the compliance burden for small enterprises and facilitates the business activities of start-ups. From the Member States' perspective, it was found to allow administrations to focus monitoring on larger businesses and to avoid a possible increase of the shadow economy.
- The current domestic application of the SME exemption was pointed out as causing problems from the perspective of the Single Market. There seems to be a general agreement that the SME exemption in a Member State should be made available to eligible businesses from other Member States. The participants warned, however, against possible distortions that might result from Member States handling the exemption in a different manner. Some degree of alignment is therefore needed, and some limitation to the opening of the exemption should be foreseen.
- Graduated relief was not found to be a useful measure. It is too complex and expensive in application for both business and the tax administrations.
- Measures to tackle the threshold effect, such as a transitional period before entering the normal VAT regime, could be useful. Safeguards against abuses should be foreseen.
- A special treatment of occasional traders was not recommended since it could cause a new range of issues relating to definition and treatment of occasional traders, and because future developments in economic activities are difficult to foresee.

## 2.5. Contributions received via the REFIT platform

To some extent stakeholders also disclosed their position through the REFIT platform<sup>194</sup>, where it is possible to participate actively in the law making process by providing an overview with the aim to evaluate and improve existing laws. Some stakeholders submitted their contributions during 2015 and 2016 regarding specific VAT-related issues they are facing and the way to tackle them. All the submissions on taxation provided up to date can be found under the following [link](#)<sup>195</sup>. While the contributions received via the REFIT platform are not targeted specifically at SMEs, the issues raised which are relevant for the purposes of the SME review have been taken into account.

In this respect, for instance, it is worth referring to the submission XVIII.10.a by the Board of Swedish Industry and Commerce (NNR), which tabled the higher complexity for businesses triggered by the modification of the place of supply rules (principle of destination), given that they need to account for VAT in the Member State of consumption and "*businesses need to register for VAT from a first relevant cross-border transaction*".

---

<sup>194</sup> For more information on the REFIT programme, see [here](#).

<sup>195</sup> [https://ec.europa.eu/info/sites/info/files/taxation\\_and\\_customs\\_union.pdf](https://ec.europa.eu/info/sites/info/files/taxation_and_customs_union.pdf)

We must also highlight the submission XVIII.3.a by the Danish Business Forum (DBF), which stressed the complexity of the VAT legislation that businesses operating at EU level must face, which goes against the Single Market: *‘In the Internal Market it should in principle be just as easy to do business with a customer in Poland and Germany as with a customer in Denmark. However, because VAT rules are not harmonised the consequence is that companies that begin to trade within the internal market often encounter difficulties. Not only are there major differences between the documentation requirements, requirements of signatures, invoice requirements and texts on the invoices, but the challenges are growing with the introduction of rules on reverse liability, various distinctions and definitions of delivery point and different rates of VAT. An older study from the Confederation of Danish Industry that focused on SMEs showed that approximately 9 out of 10 companies had little or no knowledge of VAT regulation in other EU countries’.*

### 3. OVERVIEW OF THE CONSULTATION RESULTS

**Table 15: Overview of the consultation results (by stakeholder category)**

Stakeholders <sup>196</sup>	Overview of results
Businesses (SMEs in particular)	<ul style="list-style-type: none"> <li>• SMEs found the current rules for SMEs in the VAT Directive to be complex and costly to apply, and were in general supportive of their review.</li> <li>• They stressed the need for an SME scheme and, in particular, an SME exemption. A clear majority was in favour of the SME scheme (and the SME exemption) being mandatory for Member States, and optional for businesses. They also supported opening up the SME exemption to suppliers from other Member States (fully or partially). The graduated relief and flat-rate schemes were not considered to be very useful measures.</li> <li>• There was a general agreement for the need to further simplify VAT obligations among SMEs. A majority of them also indicated that such simplified VAT obligations should be mandatory for Member States, aligned at EU level, and made available to all SMEs irrespective of whether they use the SME exemption.</li> <li>• SMEs strongly agreed that small enterprises should be able to benefit from the SME exemption if their turnover temporarily exceeds the threshold.</li> <li>• The views of SMEs on the VAT treatment of occasional traders were diverse. While the majority of SMEs indicated that occasional traders should be covered by VAT, a significant portion of them were of the opinion that they should not fall within the scope of VAT.</li> </ul>
Business associations <sup>197</sup>	<ul style="list-style-type: none"> <li>• Business associations agreed with SMEs that the current rules for SMEs in the VAT Directive are complex and costly to apply, and were in general supportive of their review.</li> <li>• They stressed the need for an SME scheme and, in particular, an SME exemption. Business associations had divided opinions as to whether the SME scheme (and the SME exemption) should be optional for Member States, but a clear majority said that it should remain optional for businesses. They were in favour of opening up the SME exemption to suppliers from other Member States (fully or partially), while acknowledging that some limitations may be necessary. The graduated relief and flat-rate schemes were not considered to be very useful measures.</li> <li>• They also highlighted the need to further simplify VAT obligations. A majority also indicated that such simplified VAT obligations should be mandatory for Member States, aligned at EU level, and made available to all SMEs irrespective of whether they use the SME exemption.</li> <li>• Business associations showed more discreet support than SMEs to allowing small enterprises to benefit from the SME exemption if their turnover temporarily exceeds the threshold. They indicated that some anti-abuse measures should be foreseen.</li> </ul>

<sup>196</sup> Feedback from academics (received via the open public consultation and the Fiscalis 2020 Workshop) and members of the public (received via the open public consultation) cannot be treated as significant.

<sup>197</sup> Including tax practitioners.



	<ul style="list-style-type: none"> <li>• There was mixed feedback as regards the VAT treatment of occasional traders. While a majority indicated that occasional traders should be covered by VAT, a significant portion believed they should not fall within the scope of VAT. However, business associations in general agreed with Member States that it is preferable to clarify how the current rules apply to occasional traders, rather than laying out new provisions.</li> </ul>
Member States	<ul style="list-style-type: none"> <li>• Member States were conscious of the VAT compliance burden faced by SMEs, but in general remained more prudent as regards the review of the current rules.</li> <li>• Member States were supportive of the SME scheme and the SME exemption in particular, which allow them to focus on monitoring larger businesses and also avoid shadow economy. Contrary to businesses and business associations, Member States would prefer to retain discretion as regards the use of the SME scheme (and the SME exemption) and also said that it should remain optional for businesses. While in favour of making the SME exemption available to suppliers from other Member States, they warned that some limitation should be foreseen to avoid possible abuse. The graduated relief and flat-rate schemes were not considered to be very useful measures.</li> <li>• Unlike SMEs and business associations, Member States preferred simplified VAT obligations to remain optional for them and were sceptical as regards their alignment at EU level, given that they depend on the national context.</li> <li>• Some Member States already allow small enterprises to continue benefitting from the SME exemption if their turnover temporarily exceeds the threshold. As regards a general implementation of such measure, it was positively perceived as a way to tackle the 'threshold effect', provided that some anti-abuse provisions are foreseen.</li> <li>• Member States found in general no need to set out new rules for clarifying the VAT treatment of occasional traders. They believed that such cases should be dealt with on a case-by-case basis and that the existing provisions in the VAT Directive (Articles 9 and 12) suffice. It would be complicated to define 'occasional traders', also in view of how quick economic activities develop.</li> </ul>

Source: Commission services

### **ANNEX 3: WHO IS AFFECTED BY THE INITIATIVE AND HOW**

#### **1) Businesses**

This initiative is targeted at micro enterprises with turnover up to EUR 2 000 000 (98% of businesses across the EU) as a simplification package will be available for these businesses, irrespective of whether they use the SME exemption. However, the review will affect in particular a much smaller group of enterprises (those with less than EUR 100 000 turnover), the ones that are most likely eligible for the SME exemption both at domestic and intra-EU level<sup>198</sup>.

As regards exempt enterprises, SMEs that currently benefit from the VAT exemption for small enterprises will continue to be exempt. In addition, they will be able to benefit from the SME exemption in Member States other than their own, to which they deliver supplies, provided that such Member States adopt the SME exemption.

All small enterprises, either exempt or non-exempt with turnover of up to EUR 2 000 000 (that do not benefit from the exemption because they opt for being taxed on the basis of the general principles or because their turnover exceeds the exemption threshold) will be able to benefit from a common minimum set of simplified VAT obligations. Such simplified VAT obligations would slightly vary, depending on whether an SME is exempt or not<sup>199</sup>.

In this respect, exempt SMEs could be released from the obligation to register (optional for Member States), and would not have to issue invoices (obligatory for Member States). Simplified VAT record keeping, as well as simplified and less frequent filing of VAT returns, would also be available.

Non-exempt SMEs (SMEs with turnover below the exemption threshold, but opting for taxation on the basis of general principles + SMEs with turnover above the exemption threshold and up to EUR 2 000 000), for instance, would have access to simplified registration, simplified VAT record keeping obligations, and less frequent filing of VAT returns.

#### **2) Member States**

Member States applying the SME exemption will be directly impacted by the changes proposed. They will need to implement the new rules and ensure their correct application by businesses. In addition, Member States not using the SME exemption may be impacted by the proposal if they decide to provide simplified VAT obligations for small enterprises outside the SME exemption. It should be kept in mind that the proposal will provide for the measures optional for both Member States and enterprises.

The estimated impact on VAT revenues is negligible. It ranges between a decrease of 0.48% and an increase of 0.28%<sup>200</sup>. The proposal should, however, encourage voluntary compliance.

---

<sup>198</sup> For further information about the number of impacted businesses, see Annex 4.

<sup>199</sup> It has been taken into account that some of such enterprises will not have to collect and pay VAT (exempt), and others will have to do so (non-exempt). This has an impact on the minimum set of obligations which could be required in order to ensure correct functioning of the VAT system and that control by tax authorities is possible.

<sup>200</sup> More details on the revenue impacts can be found in section 6 and Annex 4.

### **3) Consumers**

The initiative may bring also positive effects on consumers, because of the improvement of the small businesses' competitiveness, which are notably lower prices and other benefits, such as better quality, wider choice and innovative goods and services.

### 1. OVERVIEW OF THE METHODOLOGY

For the analysis of the policy option it was necessary to collect qualitative and quantitative information from both businesses and Member States. The assessment of the impacts was carried out through two tools: the standard cost model (SCM) and computable general equilibrium (CGE) model.

Data from tax authorities has been the main source to obtain the estimates. Other two data sources were used to integrate information collected by Member States: Eurostat's data and Mints Global's database. Further, desk research was conducted to obtain more comprehensive information at the level of granularity required.

The approach to this study is tailored to best respond to the requirements of the European Commission Better Regulation Guidelines.

Please note that the **compliance costs** of businesses include costs incurred in meeting legal obligations and also other additional costs that are not strictly due to the legal obligations (e.g. the monitoring of the VAT exemption threshold).

### 2. GENERAL ASSUMPTIONS

- **Common VAT rate.** To assess the impact on the VAT revenue an effective VAT rate was calculated at the EU level and applied to the turnover at stake in every option. Based on the ratio of total VAT revenue collected relative to final consumption, the effective VAT rate in the EU is calculated to be 12.3%.
- **Exemption thresholds.** For all of the options, it is assumed that national thresholds do not change. Furthermore, to assess the impact of the extension of the SME exemption to non-established businesses a weighted average threshold of EUR 26 000 was used.
- **B2B transactions.** For all options, it is assumed that the reverse charge mechanism would continue to apply for B2B transactions and the supplier would not have VAT obligations in the Member State of destination. Therefore, businesses engaged in B2B transactions are considered out of scope for the purposes of the analysis. As such, the compliance costs for B2B cross-border transactions are already included in the analysis of the compliance costs for businesses in Option 1.
- **Number of SMEs in the EU.** The data obtained from tax authorities is used to estimate the number of businesses and their average annual turnover within size classes<sup>201</sup>. For the purpose of the study, a specific definition of SME is adopted, which refers only to businesses with annual turnover not exceeding EUR 2 000 000 (micro-businesses, according to the EU definition).
- **Number of SMEs trading cross-border.** It is assumed that Options 2-4 will impact businesses whose value of cross-border sales in an individual Member State falls below the weighted average threshold of EUR 26 000. Further, to determine the number of eligible businesses, the following assumptions are made (using data from a Flash

---

<sup>201</sup> Defined as less than EUR 5 000, EUR 5 000 to EUR 50 000, EUR 50 000 to EUR 100 000, EUR 100 000 to EUR 500 000, EUR 500 000 to EUR 2 000 000, over EUR 2 000 000.

Eurobarometer): the proportion of SMEs' turnover which comes from cross-border sales is 27%; the proportion of SMEs trading B2C supplies cross-border is 33%. Given the inherent uncertainty, sensitivities were carried out around these assumptions.

### 3. TOOLS FOR THE ANALYSIS

#### Standard Cost Model

According to the European Commission guidelines on Impact assessment, the Standard Cost Model was used to estimate the compliance burden for businesses in order to comply with the VAT-related obligations translated into Information Obligations (IOs).

Our objective was to identify and quantify the VAT compliance costs that SMEs engaged in domestic and cross-border transactions face, within and outside the SME exemption, under the current VAT legislation (status quo) and how such costs are likely to change under the different policy options considered.

#### **Standard Cost Model:**

**Compliance burden = Time\*Price\*Quantity (amount x frequency)**

*Time:* The time spent by the citizen or the employee in the enterprises to comply with an IO (Information Obligation)

*Price:* The standard cost to apply to the time spent according to the level of the employee who performs the IO.

*Quantity:* The number of IOs to perform per year and their frequency (e.g. monthly, yearly)

Data for the exercise came from a variety of sources:

- Real data from business and accountant interviews;
- Commission's official guidelines and standardised data (for hourly costs);
- Expert assessments;
- Third party sources.

A set of basic assumptions was used in order to enhance the comparability of the results. The assumptions concern the following issues:

- **Frequency of VAT registration:** the frequency with which businesses apply for VAT registration in other Member States was assumed to be 10 years on average. It is based on the observation that generally companies register for VAT in a Member State only once, and this action therefore represents a one-off cost.
- **Frequency of changes or cancelling of VAT registration:** similarly to the above, it was assumed to be 10 years on average. It is based on the observation that this is a very infrequent event in the lifespan of a company.
- **Number of invoices:** the number of invoices and fiscal receipts businesses issue on a yearly basis (when they are obliged to issue them) vary greatly across sectors. Based on the information collected during fieldwork, an average of 20 invoices/fiscal receipts per month was considered in the analysis. However, in order to account for such variance, sensitivity analysis was carried out using a larger amount of average invoices/fiscal

receipts per year (30 per month, 360 per year), in order to assess the relevance of such costs for the overall compliance costs for businesses.

- **Advisory costs:** data collected via the fieldwork did not allow us to identify the costs of advisory fees for each of the IOs to which they apply. Both businesses and accountants provided us with the lump-sum fees they normally pay (or charge, in the case of the accountants) for the set of obligations relevant to the analysis. Therefore, we decided to add such costs as a lump-sum to the internal costs of businesses.

### Computable general equilibrium model

In order to estimate the wider economic impacts of each policy option at European level, a Computable general equilibrium (CGE) model has been developed.

The model is based on a set of equations describing the behaviours of key actors in the EU economy – firms, households, the government and the foreign sector – and how their interactions shape the markets (equilibrium output, investment, consumption and prices). For the purpose of this analysis, the standard model was adapted to specifically focus on the contribution of SMEs to the EU economy and on the potential impacts of the policy options. A distinction is made between domestic, intra-EU and non-EU transactions in order to reflect the fact that these transactions may differ in their VAT treatment and hence in the effective VAT rate faced by consumers.

The inputs to the model are based on the policy options and vary in terms of changes in the VAT revenues, changes in the compliance burden faced by SMEs, changes in the economic activity of SMEs, changes in cross-border trade by SMEs.

The CGE model draws on three main sources of data:

- **Macro-economic data for the EU-28:** The majority of the data required for the baseline CGE model can be found in a social accounting matrix for the EU; this is a square matrix that represents the various transactions made between commodities, factors and institutions taking place in an economy. This matrix is constructed using supply and use tables and national accounts data from Eurostat.
- **Data on the contribution of SMEs:** data was collected on the contribution of SMEs to the EU economy. This was used to assess the extent to which the policy options affect the size of the market and employment.
- **Data on the compliance burden:** The information required for the scenario analysis comes from the outputs of the Standard Cost Model. This data includes the compliance burden associated with the different policy options and estimates of the impact of changing the VAT threshold.

Some of the **key economic outputs** estimated by the CGE model at the EU aggregate level are: the output and growth of the different sectors, investment, employment by different types of labour, demand and consumer prices, government revenues.

#### 4. QUANTIFICATION OF IMPACTS

##### Impact on business compliance costs

Table 16 below shows the resulting impact of Option 2 on the compliance costs, depending on the simplification measures used and the number of businesses impacted for all possible choices.

**Table 16: Impacts on compliance costs under Option 2**

Option 2	High level of simplification			Medium level of simplification			Minimal level of simplification		
	Scenario 1			Scenario 2			Scenario 3		
	Cost per 1 business (1 MS) EUR	No of businesses	Compliance cost (EUR billion)	Cost per 1 business (1 MS) EUR	No of businesses	Compliance cost (EUR billion)	Cost per 1 business (1 MS) EUR	No of businesses	Compliance cost (EUR billion)
<b>Businesses trading domestically</b>									
Businesses exempt from VAT	297	11 200 000	3.3	716	11 200 000	8.0	1 044	11 200 000	11.7
Businesses in simplified regime	887	5 700 000	5.1	975	5 700 000	5.6	1 047	5 700 000	6.0
Businesses in standard VAT regime	2 964	15 000 000	44.6	2 964	15 000 000	44.6	2 964	15 000 000	44.6
<b>Businesses trading cross-border</b>									
Businesses using the extended OSS	690	120 000	0.08	690	290 000	0.20	690	460 000	0.32
Businesses in cross-border exemption scheme	297	460 000	0.14	716	290 000	0.21	1 044	120 000	0.12
<b>Overall compliance costs</b>	<b>53.2</b>			<b>58.6</b>			<b>62.7</b>		
<b>% change from baseline scenario</b>	<b>-22%</b>			<b>-14%</b>			<b>-8%</b>		

Source: 2017 Deloitte SME study

Tables 17 and 18 provide an overview of the impacts of number of businesses and their compliance costs under Options 3 and 4<sup>202</sup>.

<sup>202</sup> It should be noted that the calculations presented in this Annex are based on the 2017 Deloitte SME study. For the purposes of this Impact Assessment the elements of Options 3 and 4 have been modified as compared to the study. The differences between the impacts of both options are, nevertheless, of limited magnitude.

**Table 17: Impacts on compliance costs under Option 3**

Option 3	Cost per 1 business (1 MS) EUR	No of businesses	Compliance cost (EUR billion)
<b>Businesses trading domestically</b>			
Businesses exempt from VAT	[716 – 1 043]	7 400 000	7.7
Businesses in simplified regime	[975 – 1 208]	4 200 000	5.0
Businesses in transitional period	1 325	260 000	0.34
Businesses in standard VAT regime	[2 964 – 3 104]	13 700 000	42.6
<b>Businesses trading cross-border</b>			
Businesses using MOSS	690	290 000	0.20
Businesses in cross-border exemption scheme	716	290 000	0.21
<b>Overall compliance costs</b>			<b>56.1</b>
<b>% change from baseline scenario</b>			<b>-18%</b>

**Table 18: Impacts on compliance costs under Option 4**

Option 4	Cost per 1 business (1 MS) EUR	Previous compliance cost of an occasional trader	No of businesses	Compliance cost (EUR billion)
<b>Businesses trading domestically</b>				
Businesses exempt from VAT	[716 – 1 043] <sup>203</sup>	83	7 400 000	7.7
Businesses in simplified regime	[975 – 1 208] <sup>204</sup>	342	4 200 000	5.0
Businesses in standard VAT regime	[2 964 – 3 104] <sup>205</sup>	1 114	14 000 000	43.4
<b>Businesses trading cross-border</b>				
Businesses using MOSS	690		290 000	0.20
Businesses in cross-border exemption scheme	716		290 000	0.21
<b>Overall compliance costs</b>				<b>56.5</b>

<sup>203</sup> Since the businesses falling out of the VAT system had lower than average VAT compliance costs, the average compliance cost of businesses remaining may be higher than previously estimated. However, it is uncertain where these businesses lie on the distribution so a range is reported.

<sup>204</sup> *Ibid.*

<sup>205</sup> *Ibid.*



Option 4	Cost per 1 business (1 MS) EUR	Previous compliance cost of an occasional trader	No of businesses	Compliance cost (EUR billion)
<b>% change from baseline scenario</b>			<b>-17%</b>	

Source: 2017 Deloitte SME study

### Impact on Member States' VAT revenues

Table 19 shows the impact of Option 2 on VAT revenue at Member State level. The overall EU decrease in revenue was allocated to individual Member States based on their share of inbound trade from other Member States (called 'EU imports' hereafter), as Member States most impacted by extending their domestic threshold to non-established businesses will be the ones with higher imports.

**Table 19: Impacts on Member States' VAT revenues under Option 2**

Member State	Absolute change in net VAT revenue collected in EUR million	Percentage change in net VAT revenue collected
<b>EU-28</b>	<b>-664.9</b>	<b>-0.06%</b>
Austria	-24.0	-0.02%
Belgium	-47.5	-0.18%
Bulgaria	-3.8	-0.10%
Croatia	-3.2	-0.07%
Cyprus	-0.8	-0.05%
Czech Republic	-21.8	-0.34%
Denmark	-11.9	-0.05%
Estonia	-2.4	-0.16%
Finland	-8.8	-0.06%
France	-78.7	-0.04%
Germany	-138.7	-0.07%
Greece	-5.1	-0.04%
Hungary	-14.2	-0.09%
Ireland	-9.9	-0.14%
Italy	-48.1	-0.06%
Latvia	-2.3	-0.15%
Lithuania	-3.8	-0.08%
Luxembourg	-3.4	-0.09%
Malta	-0.8	-0.15%
Netherlands	-46.4	-0.10%
Poland	-27.5	-0.10%
Portugal	-10.3	-0.07%
Romania	-10.8	-0.09%
Slovakia	-11.6	-0.68%
Slovenia	-4.2	-0.17%

Member State	Absolute change in net VAT revenue collected in EUR million	Percentage change in net VAT revenue collected
Spain	-38.0	-0.07%
Sweden	-19.4	-0.06%
United Kingdom	-67.5	-0.04%

Source: 2017 Deloitte SME study

The table above shows that the impact on Member States varies from a decrease in VAT revenues of 0.02% in Austria to 0.68% in Slovakia. The differences observed across Member States are impacted by two factors:

- The share of EU imports of each country: the higher the share, the higher the impact; and
- The level of net VAT revenue collected before the impact: the higher the amount of VAT revenue collected, the lower the impact.

The impact of Option 3 on VAT revenues per Member State is outlined in Table 20 below. It is calculated by estimating the average turnover generated by the businesses impacted in each Member State and applying an effective VAT rate.

The differences observed on the revenue impact across Member States can be explained by the level of the threshold (the higher the threshold, the higher the impact, as businesses impacted will have higher turnover), and the number of businesses identified within the relevant turnover bracket. While the precise magnitude differs, the overall impact on revenues is limited for Member States.

**Table 20: Impacts on Member States' VAT revenues under Option 3**

Member State	Absolute change in net VAT revenue collected in EUR million due to the implementation of the transition period only (percentage change)	Absolute change in net VAT revenue collected in EUR million due to Option 3 (percentage change) – Lower bound	Absolute change in net VAT revenue collected in EUR million due to Option 3 (percentage change) – Upper bound
<b>EU-28</b>	<b>-1 853.5 (-0.18%)</b>	<b>-5 014.7 (-0.48%)</b>	<b>2 890.2 (0.28%)</b>
Austria	-24.9 (-0.03%)	-82.4 (-0.08%)	23.7 (0.02%)
Belgium	-24.5 (-0.09%)	-102.2 (-0.39%)	-6.6 (-0.03%)
Bulgaria	-7.5 (-0.19%)	-23.2 (-0.59%)	14.6 (0.37%)
Croatia	-9.9 (-0.23%)	-22.2 (-0.51%)	6.6 (0.15%)
Cyprus	-0.8 (-0.05%)	-5.3 (-0.35%)	6.3 (0.42%)
Czech Republic	-14.2 (-0.22%)	-125.6 (-1.96%)	158.0 (2.47%)
Denmark	-2.3 (-0.01%)	-76.8 (-0.31%)	121.4 (0.49%)
Estonia	-1.9 (-0.13%)	-13.1 (-0.87%)	14.9 (0.99%)
Finland	-3.7 (-0.02%)	-59.3 (-0.39%)	88.8 (0.58%)
France	-379.3 (-0.21%)	-1196.3 (-0.67%)	1141.8 (0.64%)
Germany	-59.9 (-0.03%)	-372.4 (-0.18%)	178.0 (0.09%)
Greece	-6.5 (-0.05%)	-69.3 (-0.55%)	113.3 (0.89%)
Hungary	-21.2 (-0.13%)	-95.0 (-0.59%)	93.7 (0.58%)

Member State	Absolute change in net VAT revenue collected in EUR million due to the implementation of the transition period only (percentage change)	Absolute change in net VAT revenue collected in EUR million due to Option 3 (percentage change) – Lower bound	Absolute change in net VAT revenue collected in EUR million due to Option 3 (percentage change) – Upper bound
Ireland	-29.0 (-0.41%)	-52.6 (-0.74%)	-9.2 (-0.13%)
Italy	-361.9 (-0.42%)	-555.0 (-0.64%)	-96.0 (-0.11%)
Latvia	-5.1 (-0.34%)	-16.2 (-1.07%)	11.7 (0.77%)
Lithuania	-8.8 (-0.18%)	-24.2 (-0.49%)	12.5 (0.25%)
Luxembourg	-2.4 (-0.06%)	-9.0 (-0.23%)	1.3 (0.03%)
Malta	-1.4 (-0.28%)	-5.2 (-1.02%)	4.4 (0.84%)
Netherlands	0 (0%)	-147.6 (-0.31%)	172.7 (0.37%)
Poland	-209.5 (-0.78%)	-371.4 (-1.38%)	54.2 (0.20%)
Portugal	-7.3 (-0.05%)	-79.2 (-0.54%)	116.0 (0.79%)
Romania	-28.7 (-0.25%)	-74.2 (-0.64%)	35.5 (0.30%)
Slovakia	-20.0 (-1.18%)	-80.7 (-4.75%)	74.6 (4.38%)
Slovenia	-9.9 (-0.42%)	-22.8 (-0.96%)	4.8 (0.2%)
Spain	0 (0%)	-254.0 (-0.49%)	429.9 (0.83%)
Sweden	0 (0%)	-116.1 (-0.35%)	190.1 (0.58%)
United Kingdom	-613 (-0.40%)	-963.9 (-0.63%)	-66.5 (-0.04%)

Source: 2017 Deloitte SME study

The impact of Option 4 on VAT revenues for each Member State, incorporating the effects of Option 2, is presented in the table below. It was calculated by allocating the overall change in revenue at the EU-level from this additional measure to individual Member States based on the share of businesses impacted.

**Table 21: Impacts on Member States' VAT revenues under Option 4**

Member State	Absolute change in net VAT revenue collected in EUR million due to Option 4 (percentage change) – Lower bound	Absolute change in net VAT revenue collected in EUR million due to Option 4 (percentage change) – Upper bound
<b>EU-28</b>	<b>-3 161.2 (-0.30%)</b>	<b>4 743.7 (0.46%)</b>
Austria	-57.5 (-0.06%)	48.6 (0.05%)
Belgium	-77.7 (-0.29%)	17.9 (0.07%)
Bulgaria	-15.7 (-0.40%)	22.1 (0.56%)
Croatia	-12.3 (-0.28%)	16.5 (0.38%)
Cyprus	-4.5 (-0.30%)	7.1 (0.47%)
Czech Republic	-111.4 (-1.74%)	172.2 (2.69%)
Denmark	-74.5 (-0.30%)	123.7 (0.49%)
Estonia	-11.2 (-0.74%)	16.8 (1.11%)
Finland	-55.6 (-0.36%)	92.5 (0.61%)
France	-817 (-0.46%)	1521.1 (0.85%)
Germany	-312.5 (-0.15%)	237.9 (0.12%)
Greece	-62.8 (-0.50%)	119.8 (0.95%)

Member State	Absolute change in net VAT revenue collected in EUR million due to Option 4 (percentage change) – Lower bound	Absolute change in net VAT revenue collected in EUR million due to Option 4 (percentage change) – Upper bound
Hungary	-73.8 (-0.46%)	114.9 (0.71%)
Ireland	-23.6 (-0.33%)	19.8 (0.28%)
Italy	-193.1 (-0.22%)	265.9 (0.31%)
Latvia	-11.1 (-0.73%)	16.8 (1.11%)
Lithuania	-15.4 (-0.31%)	21.3 (0.43%)
Luxembourg	-6.6 (-0.17%)	3.7 (0.09%)
Malta	-3.8 (-0.74%)	5.8 (1.12%)
Netherlands	-147.6 (-0.31%)	172.7 (0.37%)
Poland	-161.9 (-0.60%)	263.7 (0.98%)
Portugal	-71.9 (-0.49%)	123.3 (0.84%)
Romania	-45.5 (-0.39%)	64.2 (0.55%)
Slovakia	-60.7 (-3.57%)	94.6 (5.56%)
Slovenia	-12.9 (-0.54%)	14.7 (0.62%)
Spain	-254 (-0.49%)	429.9 (0.83%)
Sweden	-116.1 (-0.35%)	190.1 (0.58%)
United Kingdom	-350.9 (-0.23%)	546.5 (0.35%)

Source: 2017 Deloitte SME study

The **discrepancies** observed can be due to:

- The share of businesses impacted in a given Member State compared to the overall number of businesses impacted, as this is the basis on which the EU change in VAT revenue is allocated to Member States. Hence, the higher the share, the higher the impact; and
- The level of net VAT revenue collected before the impact: the higher it is, the lower the impact will be in proportional terms.

#### Number of businesses impacted

**Option 2.** Based on the above assumptions, the estimated number of businesses that would potentially benefit from the extension of the SME exemption is around **1.64 million**, or 33.9% of all businesses in the EU. These businesses generate only 0.11% of the overall turnover in the EU, and the turnover at stake (i.e. generated from the cross-border sales and subject to exemption under this policy option) represents only 0.03% of EU turnover.

**Option 3.** Mint Global data was used to estimate the number of businesses with turnover between the VAT exemption threshold and 150% of the threshold in a given Member State. This was done by taking the number of businesses in each relevant bracket estimated as part of the status-quo analysis, and using Mint Global data to estimate the proportion lying between the lower/upper bound of this bracket and the relevant thresholds. Based on the above methodology, the estimated proportion of businesses impacted by this option at EU-level is 0.6% (or 260 000 businesses).

**Option 4.** Using data from tax authorities, it is expected that only the smallest businesses (turnover below EUR 5 000) will potentially classify as occasional traders. These traders represent about 38% of all businesses in the EU, but only 0.04% of the generated turnover. Furthermore, it was observed that occasional traders are more likely to be single individuals without employees rather than legal entities. Based on the information received from some Member States on the number of sole traders, it was finally estimated that around 40% of businesses with less than EUR 5 000 turnover could classify as occasional traders (15.1% of all EU businesses or 6.4 million businesses).

## ANNEX 5: MEASURES FOR SMEs AVAILABLE IN THE VAT DIRECTIVE

The VAT Directive sets out several provisions, optional for Member States to apply, designed to alleviate the burden that small enterprises have in dealing with VAT. While some of those provisions are part of a special scheme for small enterprises ('SME scheme'), there are other simplification measures available for small enterprises outside of the SME scheme. The measures can, broadly speaking, be grouped in the following categories:

- 1) Simplified VAT obligations
  - 2) Simplified procedures for charging and collecting VAT
  - 3) SME exemption
- 
- 1) Simplified VAT obligations (outside of the SME scheme)

The VAT Directive provides for simplified procedures in relation to several VAT obligations; notably VAT registration, invoicing, accounting, reporting and payment of VAT. See below an outline of what these VAT obligations consist in, and how they may be simplified for small enterprises.

- **VAT registration:** Businesses are generally required to register for VAT purposes (i.e. to state when their activity as a business starts, changes or ceases) pursuant to Article 213 of the VAT Directive. Many Member States release exempt small enterprises which benefit from the SME exemption from the obligation to register for VAT purposes on the basis of Article 272(1)(d) of the VAT Directive. However, such small enterprises may still be required to register for VAT purposes in other Member States where, for instance, they trade cross-border within the EU according to Article 214. See [here](#) for more information.
- **VAT invoicing:** In general, businesses have to issue invoices for every supply made (the specific cases where an invoice is required are laid down in Article 220 of the VAT Directive). Although not specifically targeted towards small enterprises, Articles 220a and 238-240 of the VAT Directive allow Member States to permit the use of simplified invoicing under certain circumstances. Member States may also, pursuant to Article 272(1)(d) of the VAT Directive, release businesses covered by the SME exemption from the obligation to issue invoices. See [here](#) for more information.
- **VAT accounting ('VAT record keeping'):** Businesses are required to keep their accounts in sufficient detail for VAT to be collected and declared, and such procedure to be checked by the tax authorities, pursuant to Article 242 of the VAT Directive. No rules are set for the length of the period during which accounts must be kept. Member States may release small enterprises covered by the SME exemption from the obligation to keep VAT accounts pursuant to Article 272(1)(d) of the VAT Directive. Article 272(3) of the VAT Directive also allows Member States to release taxable persons other than those covered by the SME exemption from certain of the accounting obligations referred to in Article 242 of that Directive.
- **VAT reporting (VAT returns and recapitulative statements):** Under normal VAT arrangements, businesses are required to prepare and submit periodical VAT returns (mostly either monthly or quarterly) and recapitulative statements ('EU Sales Lists') pursuant to Articles 250 and 262 of the VAT Directive respectively.

- **VAT returns:** Businesses submit VAT returns to their tax administrations, where they indicate which are the transactions made, the VAT that they have charged to their customers (output VAT), the VAT that they have paid to their suppliers (input VAT), and the amount of VAT payable or refundable (difference between output VAT and input VAT). How often VAT returns have to be submitted depends on each Member State. While the VAT Directive only requires VAT returns to be made at least once a year (Article 252 of the VAT Directive), in practice many Member States require VAT returns to be submitted monthly or quarterly. In addition to these periodic VAT returns, Member States may also require an annual VAT return, as set out in Article 261 of the VAT Directive, summarising for the year the periodic information already submitted.

Such obligations may be simplified for small enterprises. For instance, some Member States have set up longer periods for the filing of VAT returns (e.g. every six months, instead of monthly or quarterly) for small enterprises; and Member States can also release small enterprises covered by the SME exemption from the obligation to submit periodical and/or annual VAT returns on the basis of Article 272(1)(d) of the VAT Directive. As regards the content of VAT returns, certain minimum requirements are set out in Articles 250 and 251 of the VAT Directive, but there are no common standards at EU level. See [here](#) for more information.

- **Recapitulative statements ('EU sales lists'):** Businesses making intra-EU supplies submit recapitulative statements to their tax administrations, usually on a monthly or quarterly basis, indicating the enterprises in other Member States to whom they have supplied goods and services. Member States may also permit businesses to submit them annually rather than monthly or quarterly, provided that the conditions laid down in Article 270 of the VAT Directive are met. Member States may also align the periodicity of their filing with a longer periodicity for the filing of the VAT return pursuant to Article 271 of the VAT Directive.
- **VAT payment:** Obligation to pay the VAT due on a transaction to the taxable authorities. The person liable to pay is usually the supplier, but it may also be the customer (e.g. where the customer is a business making an intra-EU acquisition of goods), pursuant to Articles 192a-205 of the VAT Directive. Some Member States offer small enterprises some flexibility on their VAT payments, such as the cash accounting scheme, with a view to support their cash flow. See [here](#) for more information.
  - **Cash accounting scheme:** Member States may apply the cash-accounting scheme pursuant to Articles 66(b) and 167a of the VAT Directive, in order to support the cash-flow of businesses having to collect and pay VAT. According to this scheme, businesses account for the VAT charged (output VAT) only when they have received payment from their customers, and deduct the VAT paid (input VAT) only once the purchases have been paid to their suppliers. The legislation sets out that the full cash accounting scheme (applied to both output and input VAT) is available to businesses whose turnover does not exceed EUR 500 000, although there is the possibility to use a higher threshold up to a maximum of EUR 2 000 000 following a consultation of the VAT Committee. It is worth noting that some Member States restrict the application of the cash accounting scheme to the output VAT only (and not input VAT). Cash accounting usually entails an additional compliance burden for the businesses applying it, due to the need to account for the financial movements of the transactions.

## 2) Simplified procedures for charging and collecting VAT (part of the SME scheme)

Member States may, according to Article 281 of the VAT Directive and after consulting the VAT Committee, apply simplified procedures such as flat-rate schemes for charging and collecting VAT, provided that they do not lead to a reduction thereof.

- Flat-rate scheme:** Member States may apply a flat-rate scheme, which simplifies the calculation of the VAT due by SMEs. The design of such schemes may vary depending on the Member State having introduced it, but three main models can be identified: (i) some apply a flat-rate on the amount of sales directly and allow businesses no right to deduct the VAT paid on their purchases; (ii) others apply a normal VAT rate on the amount of sales, and allow businesses to deduct a fixed amount of the VAT paid on their purchases; and (iii) a combination of both models. In most of the cases, such flat-rate schemes are applied domestically. Some Member States base the eligibility for the scheme on businesses being below certain turnover thresholds, while others apply the scheme only to certain business sectors, or apply it in general to all the sectors but have sector specific flat-rates.

See below an example of the application of the flat-rate scheme according to the first model above, that is, only applied on the amount of sales (scenario 2); compared to the application of the normal provisions in the VAT Directive (scenario 1). In the example, we assume an applicable VAT rate of 20% and a flat-rate of 10%; that an SME buys raw materials from a supplier for EUR 100 (adding 20% VAT, results in EUR 120 paid); and that this same SME sells the manufactured goods for a price of EUR 200 (adding 20% VAT, results in EUR 240 charged). While in scenario 1 the VAT due to be paid by the SME to the tax authorities is of EUR 20 (EUR 40 in output VAT – EUR 20 of input VAT), in scenario 2 the SME calculates the VAT due by multiplying a flat-rate of 10% to the total price of outputs (EUR 200).

**Figure 12: Example of the application of the flat-rate scheme**

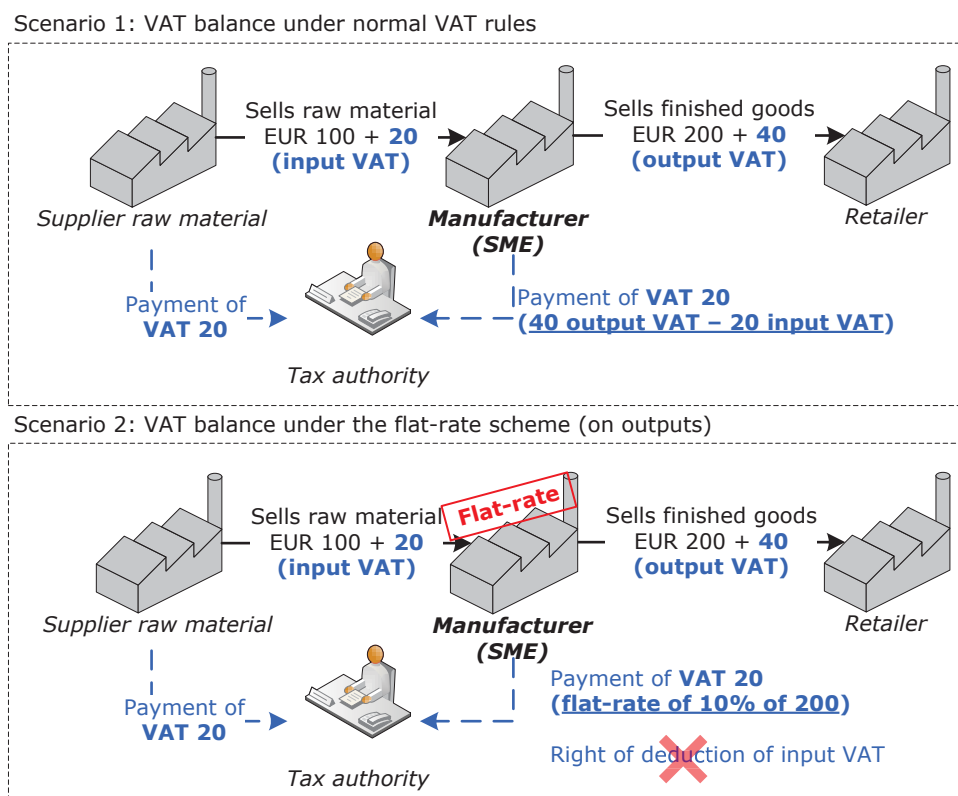



### 3) SME exemption (part of the SME scheme)

Member States may, pursuant to Articles 281-294 of the VAT Directive, introduce VAT relief measures under which a business established in a particular Member State, whose turnover does not exceed the specified threshold, may be exempted from VAT. Such VAT relief measures are the SME exemption and the graduated relief.

- **SME exemption:** The SME scheme allows Member States to exempt small enterprises from VAT provided that their annual turnover does not exceed a certain threshold. Such an exemption is optional for Member States to apply. If available in their Member State, it is also optional for SMEs to apply. In this respect, eligible businesses may decide to opt out of the exemption and apply normal VAT rules in cases where taxation, which entails deduction of VAT paid on their purchases (input VAT), is more favourable than being under the exemption without the right of deduction.

The SME exemption, if available in a Member State, is subject to a strict territorial application (i.e. it is available to small enterprises established in the territory of that Member State only for their domestic supplies) pursuant to Article 283(1)(c) of the VAT Directive. Moreover, the exemption does not apply to certain transactions laid down in Article 283 of the VAT Directive (e.g. supplies of new means of transport), and Member States may exclude other transactions from the exemption. The thresholds under which the exemption applies are determined in relation to the annual turnover of the businesses as set out in Article 288 of the VAT Directive. As regards VAT obligations, Article 272(1)(d) of the VAT Directive allows Member States to release businesses covered by the SME exemption from certain or all VAT obligations. Exceeding the exemption threshold implies in most Member States having to comply right away with all VAT obligations under the normal rules.

See below an example of the application of the SME exemption (scenario 2); compared to the application of the normal provisions in the VAT Directive (scenario 1), where we assume an applicable VAT rate of 20%. Scenario 1 is as explained in previous Figure 12 (flat-rate). As regards scenario 2, the SME acquires raw materials at the same price of EUR 100 (adding 20% VAT, results in EUR 120 paid). However, given that the SME is exempt and pays no VAT to the tax authorities, it cannot deduct the VAT paid. Therefore, the EUR 20 of input VAT constitutes a cost for the business. If we assume that the SME wishes to retain the same margin, the sales price must increase to EUR 220.

**Figure 13: Example of the application of the SME exemption**

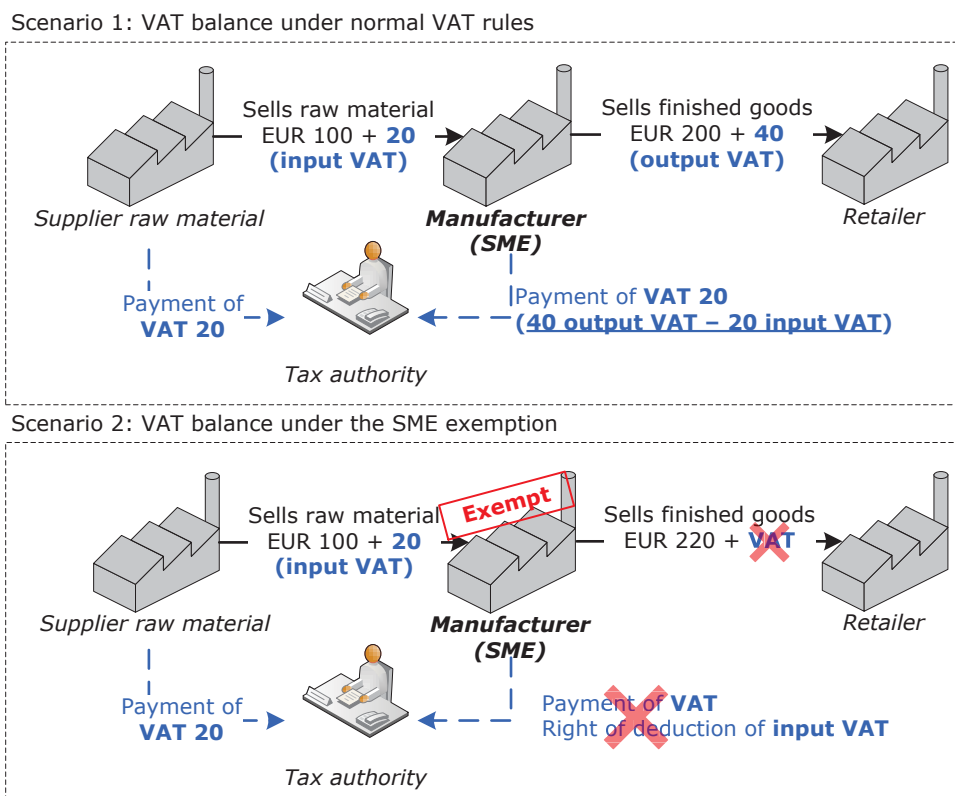

Source: Commission services based on the 2017 Deloitte SME study

- Graduated relief:** The SME scheme also allows Member States to apply the graduated relief, according to which the amount of VAT to be collected by a business under the measure is reduced depending on its turnover, with the relief gradually decreasing with the increase of turnover. It is a variation of the SME exemption in the sense that it also relieves small enterprises of the burden of collecting tax, although this is done gradually by means of multiple thresholds. Like the SME exemption, the graduated relief is available only to domestic businesses, and the thresholds under which the exemption applies are determined in relation to the annual turnover of the business.

As regards VAT obligations, it is worth noting that Article 272(1)(d) of the VAT Directive, which allows Member States to release businesses covered by the SME exemption from certain VAT obligations, cannot be applied to taxable persons benefiting from a graduated relief. This is confirmed by Article 291 of the VAT Directive, according to which taxable persons enjoying graduated relief are regarded as businesses subject to normal VAT arrangements.

**Figure 14: Example of the functioning of the graduated relief in the Netherlands**

<b>VAT due</b> (output VAT - input VAT)	
<b>≥ EUR 1 883</b>	• No relief
<b>EUR 1 345 &lt; EUR 1 883</b>	• Relief = 2,5 x [EUR 1 883 - (VAT due)]
<b>≤ EUR 1 345</b>	• Relief = VAT amount
<b>EUR 0</b>	• No relief

Source: 2017 Deloitte SME study

## ANNEX 6: INTERPLAY AMONG THE LEGISLATIVE PROPOSALS ON THE DESTINATION PRINCIPLE AND ADMINISTRATIVE COOPERATION

### 1. WHY ARE THE CURRENT RULES FOR SMALL BUSINESSES NOT SUSTAINABLE?

The functioning of the rules for SMEs currently provided for in the VAT Directive has been evaluated<sup>206</sup> in accordance with the Better Regulation Guidelines. The assessment confirmed, in particular, that the SME scheme laid down in Articles 281-294 suffers from several drawbacks (e.g. distortions, threshold effect, etc.), as it does not reflect the Single Market perspective. Namely, the current scheme offers a fragmented response in reducing SMEs' burden related to the application of normal VAT rules: it is targeted mostly at businesses trading domestically and in the B2C context.

As stated in section 2.2, complying with VAT rules is still extremely complex and costly for small businesses, particularly for those that trade in other Member States. With the evolution of the VAT system towards taxation at destination, compliance costs related to intra-EU trade are likely to increase due to the fact that supplier will have to charge and account for VAT in the Member State of destination, as regards all type of transactions<sup>207</sup>. The heavy burden for small businesses will therefore increase if there is no action at EU level to simplify VAT obligations. Failure to act will consequently lead to more distortions in the Single Market and negative effects for SMEs' growth.

**Figure 15: Impact of taxing at destination on the VAT rules for small businesses**

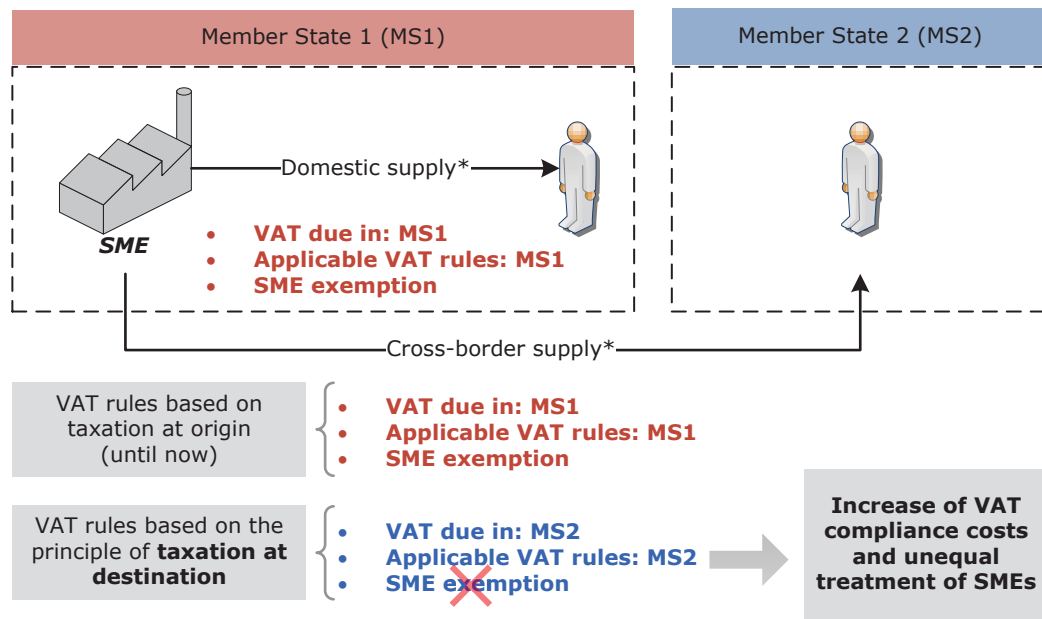

\* The VAT treatment of a supply will depend on: (i) whether it is a supply of goods or services; and (ii) whether the recipient is a business or a private consumer. In this example, we assume a supply of services from a Business to a Consumer (B2C).

Source: Commission services

<sup>206</sup> The main findings of the assessment are presented in Annex 8.

<sup>207</sup> According to the existing place of supply rules governing services, the supplier has already to declare and pay VAT in the Member State where the customer is located (Article 44 of the VAT Directive). Intra-EU B2B supplies of goods on the other hand are exempt in the Member State of origin (Article 138 of VAT Directive). For more information on the destination principle, see section 2.3.4.

## 2. INTERPLAY AMONG THE LEGISLATIVE PROPOSALS ON THE DESTINATION PRINCIPLE AND ADMINISTRATIVE COOPERATION

With Directive 2008/8/EC important steps have been taken in order to ensure that VAT on services accrues to the Member State of consumption. The place of supply rules for telecommunications, broadcasting and electronically supplied services, which entered into force in 2015 are indeed among the changes adopted in 2008<sup>208</sup>. The principle of taxation at destination will be further implemented by the following proposals:

- 1) E-Commerce proposal (adopted in 2016);
- 2) Definitive VAT system proposal (to be adopted in 2017), and
- 3) Administrative cooperation and anti-fraud proposal (to be adopted in 2017).

It is important to clarify how the proposals above complement each other, and how they interact with the SME VAT package.

The **e-Commerce proposal** stems from the need to minimise the burden attached to cross-border e-Commerce arising from different B2C VAT regimes (e.g. distance selling, imports of goods, exemption for small consignments). In line with the destination principle, the proposal therefore removes the exemption on imports and the distance selling thresholds and in parallel introduces significant simplification measures through the extension of the current Mini One Stop Shop (MOSS) which would be applicable to all B2C supply of goods and services. The new One Stop Shop will then allow businesses, also SMEs, to make a single declaration and payment in their own Member State in respect of B2C sales in other Member States. Additionally, to further simplify VAT compliance related to these changes, the e-Commerce proposal provides for a common EU annual threshold of EUR 10 000 for cross-border B2C supplies of goods and services, below which small enterprises will be able to treat their cross-border transactions as domestic. Businesses, with a low value of intra-EU sales, will therefore not have to register and account for VAT in other Member States.

The common EU threshold is, however, independent of the existing exemption thresholds for small businesses<sup>209</sup>. If the EUR 10 000 threshold is exceeded, a business will have to tax its transactions in the Member State where the customer is established<sup>210</sup>. In order to minimise the impact for such businesses of having to declare and pay VAT at the Member State of destination and consequently support their cross-border activity, the **SME package** envisages that small businesses could benefit to a certain extent from the SME exemption in the destination Member State.

The **definitive VAT system proposal** attempts to replace the current VAT arrangements, according to which a B2B cross-border supply of goods within the EU is currently split into two different transactions for VAT purposes: 1) an intra-EU supply of goods exempt in the Member

---

<sup>208</sup> From 1 January 2015 these services are taxable at the place where the customer belongs. For an overview of the 2015 place of supply rules, see [here](#). Council Implementing Regulation (EU) No 1042/2013 of 7 October 2013 amending Implementing Regulation (EU) No 282/2011 as regards the place of supply of services ([OJ L 284, 26.10.2013, p. 1](#)); and Council Regulation (EU) No 967/2012 of 9 October 2012 amending Implementing Regulation (EU) No 282/2011 as regards the special schemes for non-established taxable persons supplying telecommunications services, broadcasting services or electronic services to non-taxable persons ([OJ L 290, 20.10.2012, p. 1](#)).

<sup>209</sup> It is calculated on the basis of the turnover derived from cross-border supplies. See Article 59c of the [e-Commerce proposal](#).

<sup>210</sup> It will, in such circumstances, be possible for businesses to make use of the MOSS to declare and pay VAT in their own Member State in respect of sales in other Member States.

State of origin (made by the supplier); 2) an intra-EU acquisition of goods taxed in the Member State of destination (made by the customer). With the new rules, the exemption for the B2B cross-border supply of goods will disappear and businesses making such supplies will be liable for declaring and paying VAT in the Member State of arrival of the goods. In order to minimise the burden for SMEs making intra-EU transactions on goods, the SME package will allow them to benefit from simplified VAT obligations irrespective of whether they make use of the SME exemption.

It is important to note that both the e-commerce and the definitive VAT system proposals focus on specific types of transactions. The SME proposal on the other hand will offer a comprehensive simplification package that will be available for all types of small business activity: domestic, intra-EU, B2C and B2B supplies of goods and services.

The **Administrative cooperation and anti-fraud proposal** plays an important role in securing the success of the above-mentioned proposals, as it will provide actions to improve administrative cooperation instruments in the field of VAT and combat cross-border VAT fraud by a swifter and more coordinated reaction capacity. Given that the proposal would mainly lead to the implementation of new exchanges or a better use of already existing information, businesses are not directly affected.

The table below summarises the main legislative proposals and how they interact.

**Table 22: Interplay among the legislative proposals on the destination principle**

Type of transaction	Supply of goods		Supply of services	
<b>Business to Business (B2B)</b>	<ul style="list-style-type: none"> <li>Definitive VAT system proposal</li> </ul>	<i>Exempt supply + taxed intra-EU acquisition to be replaced by a single transaction taxed at destination</i>	<ul style="list-style-type: none"> <li>SME VAT package</li> </ul>	<i>Supplies already taxed at destination, in general. SME exemption to be opened up to small businesses from other Member States</i>
	<ul style="list-style-type: none"> <li>SME VAT package</li> </ul>	<i>SME exemption to be opened up to small businesses from other Member States</i>		
<b>Business to Consumer (B2C)</b>	<ul style="list-style-type: none"> <li>e-Commerce proposal</li> </ul>	<i>Supplies to be taxed at destination except if below an EU-wide threshold of EUR 10 000 (if applied)</i>	<ul style="list-style-type: none"> <li>e-Commerce proposal</li> </ul>	<i>Supplies to be taxed at destination except if below an EU-wide threshold of EUR 10 000 (if applied)</i>
	<ul style="list-style-type: none"> <li>SME VAT package</li> </ul>	<i>SME exemption to be opened up to small businesses from other Member States above the EUR 10 000 threshold (if applied)</i>		
<ul style="list-style-type: none"> <li>Administrative cooperation and anti-fraud proposal: Improved administrative cooperation instruments and fight against VAT fraud</li> </ul>				

Source: Commission services

## ANNEX 7: FUNCTIONING OF OPTION 2 IN AN INTRA-EU CONTEXT

According to Option 2, as outlined in section 5.2.2, the SME exemption in a Member State (where the VAT is due) would be applicable to non-established EU businesses having to declare VAT in that Member State (e.g. because their cross-border supplies exceed the common EU threshold, or because they have decided to opt out of that threshold). A non-established business would be eligible for applying the SME exemption in the Member State of destination whose VAT rules will apply.

However, safeguards could be necessary in order to prevent distortions caused by the opening up of the SME exemption. Hence, several scenarios with different degrees of safeguards have been considered:

- Option 2A – No safeguards: SME exemption fully applicable
- Option 2B – Safeguards: EU turnover threshold
- Option 2C – Safeguards: EU turnover threshold and limit in the application of the SME exemption

See below an explanation of each option, and examples of how they would work in practice.

- *Option 2A – No safeguards: SME exemption fully applicable*

The national SME exemption would open to non-established EU businesses which meet the criteria set by the Member State of destination. The threshold(s) set by each Member State would apply in the same way to both domestic and non-established businesses. In this respect, the annual turnover to be taken into account would be that generated by a business in the Member State of destination only (with the exception of cross-border supplies which are deemed to be domestic, if the common EU threshold is applied). Use of the SME exemption in the Member State of destination would not preclude businesses from using the SME exemption in the Member State where they are established, if available. They may also use the optional common EU threshold of EUR 10 000 to treat as domestic supplies the B2C sales of goods and services in other Member States.

This option has an advantage for the Member States of destination as it limits the control only to the turnover generated by supplies from non-established businesses in their territory. The main downside is that it will not prevent a situation of abuse where large companies with low turnover in each Member State could apply the SME exemption.

**Figure 16: Example Option 2A**

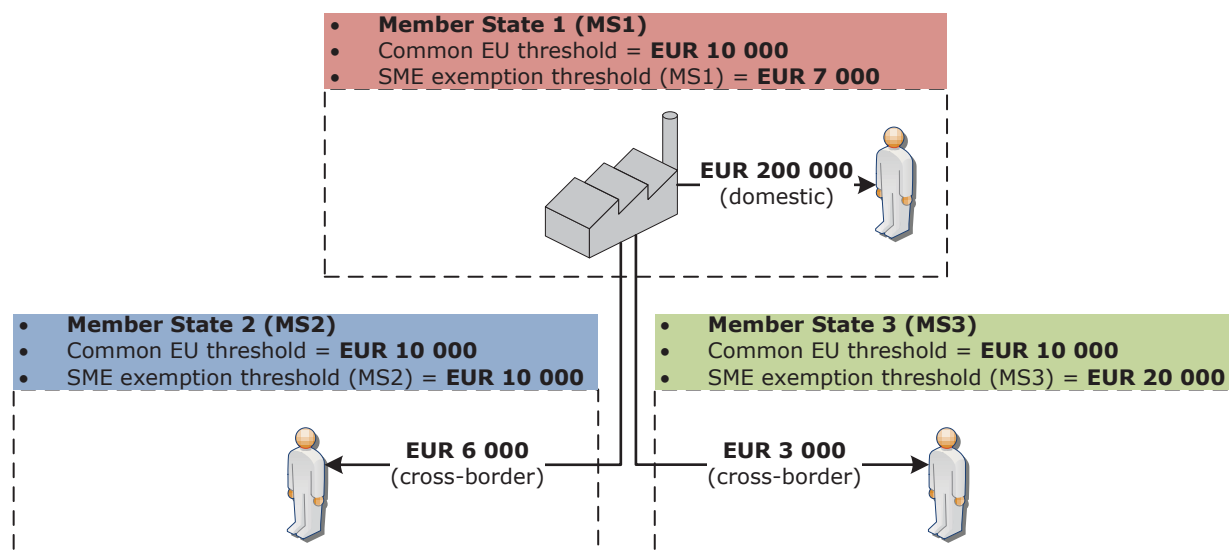

Source: Commission services

In the example above, we have assumed a business established in Member State 1 (MS1), making domestic supplies for EUR 200 000, and making cross-border supplies to Member State 2 (MS2) and to Member State 3 (MS3) for EUR 6 000 and EUR 3 000 respectively. It is also assumed that the common EU threshold of EUR 10 000 applies (as explained in section 5.2.1 and Figure 4), and that the SME exemption is available in all Member States, with different SME exemption thresholds (EUR 7 000 for MS1, EUR 10 000 for MS2, and EUR 20 000 for MS3).

At domestic level, the business has a revenue of EUR 200 000, which excludes it from the possibility of applying the exemption in MS1 (the revenue exceeds the exemption threshold of EUR 7 000).

At cross-border level, the business could decide to make use of the common EU threshold, since the total turnover derived from cross-border trade is EUR 9 000 (EUR 6 000 + EUR 3 000), which is below the EUR 10 000 common EU threshold. It could then treat their supplies in MS2 and MS3 as domestic supplies. In such circumstances, it would still not be possible to apply the SME exemption in MS1, since the total of domestic supplies is EUR 209 000 (EUR 200 000 + EUR 6 000 + EUR 3 000), which is higher than the exemption threshold of EUR 7 000. However, the business could make use of the SME exemption available in MS2 and MS3 cumulatively, because the turnover generated in each of such Member States is lower than their respective SME exemption thresholds (EUR 6 000 turnover, below the SME exemption threshold of EUR 10 000 in MS2; and EUR 3 000 turnover, below the SME exemption threshold of EUR 20 000 in MS2).

- *Option 2B – Safeguards: EU turnover threshold*

The national SME exemption would be open to non-established EU businesses which meet the criteria set by the Member States of destination, as explained in Option 2A. However, for a business to be able to apply the SME exemption, its overall EU turnover would have to be below a certain maximum threshold, set at EU level (e.g. EUR 100 000). This EU turnover threshold would be calculated on the basis of the turnover derived from all supplies made by businesses within the EU, both domestic and intra-EU. Its use would be compatible with the national SME



exemption thresholds applicable in each Member State and the optional use of the common EU threshold.

While the opening up of the SME exemption would still be targeted at small businesses, this option would require important efforts stemming from the need to control and monitor the turnover of companies generated at EU level.

**Figure 17: Example Option 2B**

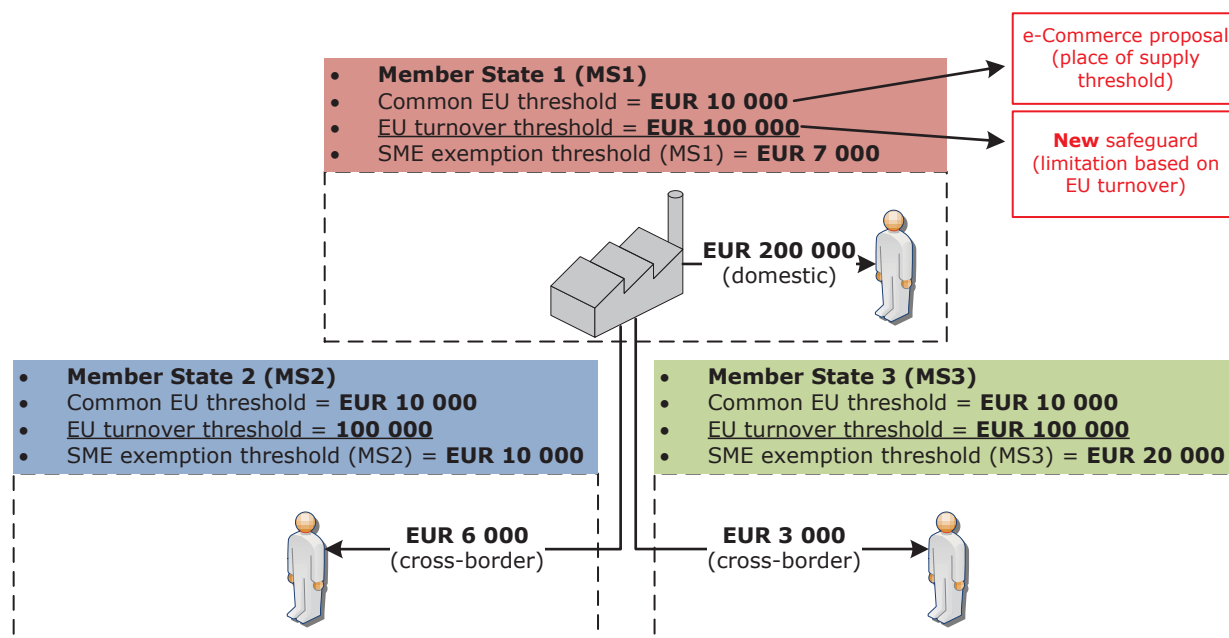

Source: Commission services

This example reproduces the scenario already described for Option 2A, while including an overall EU turnover of EUR 100 000, in order to target the opening up of the SME exemption to small businesses. For a business to be able to apply the SME exemption in a Member State where it is not established, the overall EU turnover of such business would have to be lower than EUR 100 000.

In the example, the business has a domestic revenue of EUR 200 000, which excludes it from the possibility of applying the exemption in MS1 (the revenue exceeds the exemption threshold of EUR 7 000).

At intra-EU level, the business could decide to make use of the common EU threshold, since the total turnover derived from cross-border trade is EUR 9 000 (EUR 6 000 + EUR 3 000), which is below the EUR 10 000 common EU threshold. It could then treat their supplies in MS2 and MS3 as domestic supplies. In such circumstances, it would still not be possible to apply the SME exemption in MS1, since the total of domestic supplies is EUR 209 000 (EUR 200 000 + EUR 6 000 + EUR 3 000), which is higher than the exemption threshold of EUR 7 000.

The overall EU turnover of the company, which includes domestic and cross-border trade, is EUR 209 000 (EUR 200 000 + EUR 6 000 + EUR 3 000). Given that such turnover is above the EU turnover threshold of EUR 100 000, the company established in MS1 could not to apply the exemption in MS2 or in MS3. However, if the EU turnover of the company was below EUR 100 000, it could make use of the SME exemption available in MS2 and MS3 cumulatively, because the turnover generated in each of such Member States is lower than their

respective SME exemption thresholds (EUR 6 000 turnover, below the SME exemption threshold of EUR 10 000 in MS2; and EUR 3 000 turnover, below the SME exemption threshold of EUR 20 000 in MS2).

- *Option 2C – Safeguards: EU turnover threshold and limit in the application of the SME exemption*

The national SME exemption would be open to non-established EU businesses which meet the criteria set by the Member States of destination, as long as the EU turnover of the business remains below a certain maximum threshold, as explained in Option 2B. Moreover, Member States would be able to limit the extent to which such a business could apply the SME exemption they provide for, by means of a lower threshold for non-established businesses which could be set by each Member State or determined at EU level.

If that limited threshold was determined by each Member State, the use of multiple thresholds for exemption in each Member State (i.e. that for domestic businesses, and that for non-established businesses), which would vary across the EU, is likely to increase the complexity of the system. If the limitation in the SME exemption threshold was nonetheless set out at EU level for all Member States (e.g. EUR 5 000), it would be simple for businesses to apply the SME exemption in the Member State of destination, given that the same threshold would apply irrespective of which Member State they are selling to.

It is however difficult to see how this latter option would succeed, given the grounds on which it was already concluded that Member States should retain flexibility in order to tailor the SME exemption thresholds to the characteristics of their domestic markets and policy environment. It therefore seems that Option 2C would make the system more complex and bring results which are inconsistent with the objective of reducing distortions.

**Figure 18: Example Option 2C**

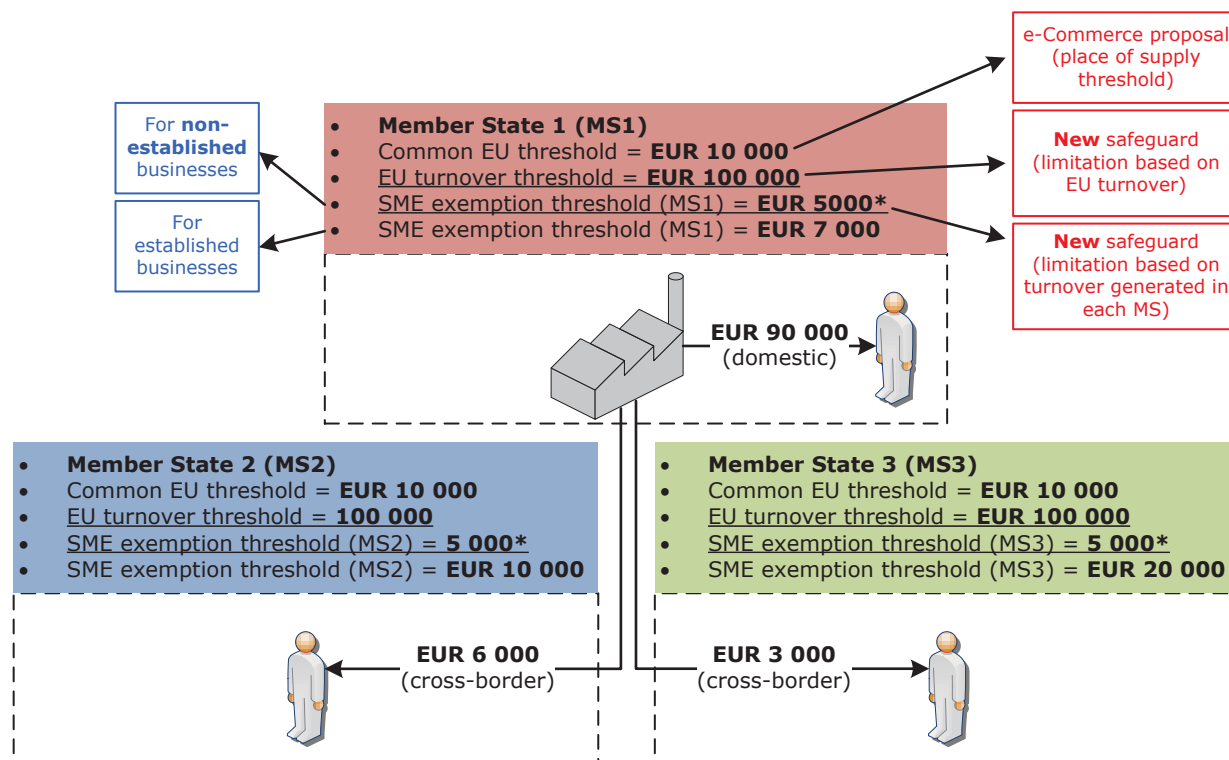

\* It is assumed that all Member States apply the same SME exemption threshold for non-established businesses, but in practice these thresholds could differ.

Source: Commission services

This example reproduces the scenario already described for Option 2B, but with two new elements: (i) the assumption that the business has a domestic turnover of EUR 90 000; and (ii) the introduction of a limitation of the application of the SME exemption by non-established businesses, by setting a specific SME exemption threshold for such businesses (lower than the SME exemption threshold applicable by domestic businesses). It is assumed that this specific threshold for non-established SMEs is harmonised at EU level at EUR 5 000.

In the example, the business has a domestic revenue of EUR 90 000, which excludes it from the possibility of applying the exemption in MS1 (the revenue exceeds the exemption threshold of EUR 7 000).

At intra-EU level, the business could decide to make use of the common EU threshold, since the total turnover derived from cross-border trade is EUR 9 000 (EUR 6 000 + EUR 3 000), which is below the EUR 10 000 common EU threshold. It could then treat their supplies in MS2 and MS3 as domestic supplies. In such circumstances, it would still not be possible to apply the SME exemption in MS1, since the total of domestic supplies is EUR 99 000 (EUR 90 000 + EUR 6 000 + EUR 3 000), which is higher than the exemption threshold of EUR 7 000.

The overall EU turnover of the company, which includes domestic and cross-border trade, is EUR 99 000 (EUR 90 000 + EUR 6 000 + EUR 3 000). Given that such turnover is below the EU turnover threshold of EUR 100 000, the company established in MS1 would be eligible for applying the exemption in MS2 or in MS3. However, the application of the exemption in such other Member States would be subject to the turnover of the company generated in each of them being below the SME exemption threshold (specific for non-established businesses) of EUR 5 000. Since the turnover generated by the SME in MS2 is EUR 6 000, which exceeds the

exemption threshold (for non-established businesses) of EUR 5 000, the business could not apply the exemption in MS2. The turnover stemming from sales in MS3 is EUR 3 000, thus below the EUR 5 000 threshold (for non-established businesses), which would allow the business to apply the exemption in MS3.

As indicated in section 5.2.2 and illustrated in the example above, Option 2C is very likely to increase the complexity of the system due to the use of multiple thresholds for exemption in each Member State (i.e. that for domestic businesses, and that for non-established businesses), and could be seen as running against the contribution to the smooth functioning of a deeper and fairer Single Market due to that differential treatment between domestic and non-established businesses.

## ANNEX 8: EVALUATION OF THE CURRENT VAT SYSTEM FOR SMES

### 1. Introduction

As part of the preparation of this initiative, the functioning of the rules for SMEs currently provided for in the VAT Directive has been evaluated. This evaluation also stems from the fact that the current SME scheme is temporary and according to Article 292 of the VAT Directive only applies until the definitive arrangements of the VAT system enter into force. Furthermore, in accordance with the Article 293 of the VAT Directive, the Commission should present to the Council, where appropriate and taking into account the need to ensure the long-term convergence of national regulations, proposals to improve the special scheme for small businesses as well as adapt the national systems and the ceilings provided for in the Directive.

The assessment covered all the SME measures currently provided for in the VAT Directive, namely, the SME scheme as laid down in Articles 281-294 and other measures outside the scheme which allow to simplify different VAT obligations (e.g. registration and invoicing).

This annex presents, in particular, the findings of the assessment of the simplified VAT obligations combined with the SME exemption which is the most implemented measure in the EU<sup>211</sup> and also the most used measure among the eligible businesses (with a participation rate of 63% on average).

It should be noted that, in VAT terms, only businesses qualifying as microenterprises according to the EU definition<sup>212</sup> (those with a turnover below EUR 2 000 000) are generally referred to as SMEs.

The analysis included in this evaluation draws in particular on the 2017 Deloitte Study<sup>213</sup>. The estimates are based primarily on data shared by tax authorities.

It should be noted that an extensive retrospective evaluation of the key elements of the EU VAT system was conducted by an external consultant in 2011<sup>214</sup> and its findings have been also used for the examination of the current SME scheme.

In accordance with the main evaluation criteria defined by the Better Regulation Guidelines<sup>215</sup>, this assessment focuses on the following key evaluation questions:

---

<sup>211</sup> 26 of 28 Member States have implemented it, with the Netherlands and Spain being the exceptions. For further information as regards the assessment of the other measures, see section 1.3 of this Impact Assessment and the 2017 Deloitte Study, Volume I, section 4.

<sup>212</sup> SMEs are generally defined at EU level according to the Commission Recommendation of 6 May 2003 concerning the definition of micro, small and medium-sized enterprises (OJ L 124, 20.5.2003, p. 36).

<sup>213</sup> Deloitte, Special scheme for small enterprises under the VAT Directive 2006/112/EC – Options for review, Final Report.

<sup>214</sup> IFS et al., 2011, A retrospective evaluation of elements of the EU VAT system, see link: [http://ec.europa.eu/taxation\\_customs/sites/taxation/files/resources/documents/common/publications/studies/report\\_evaluation\\_vat.pdf](http://ec.europa.eu/taxation_customs/sites/taxation/files/resources/documents/common/publications/studies/report_evaluation_vat.pdf)

<sup>215</sup> [http://ec.europa.eu/smart-regulation/guidelines/toc\\_guide\\_en.htm](http://ec.europa.eu/smart-regulation/guidelines/toc_guide_en.htm)

1.	What is the current situation?
2.	How effective has the EU intervention been?
3.	How efficient has the EU intervention been?
4.	How relevant is the EU intervention?
5.	How coherent is the EU intervention internally and with other (EU) actions?
6.	What is the EU added value of the intervention?

## 2. Overview of SMEs across the EU

SMEs with a turnover below EUR 2 000 000 constitute the vast majority of businesses in the EU (98%) and provide two-thirds of private sector employment within the EU. These firms operate mainly in the wholesale and retail trade, construction and professional, scientific and technical activities sectors, with the smallest businesses active in real estate or the provision of financial or administrative support services.

Most Member States have also a large proportion of nano-businesses (less than EUR 5 000 in turnover) which may generate negative net VAT revenue. These are often individuals carrying out economic activities outside of their main employment, for example occasional traders selling products online.

Despite representing the dominant form of business in the EU, small businesses only generate 15% of the total EU turnover and 25% of net VAT revenues EU-wide. The large firms contribute across all Member States over 75% of EU turnover.

The smallest businesses (those with less than EUR 50 000 turnover, representing 69% of all businesses in the EU) generate only 1% of the total turnover in the EU and produce a negligible or even negative amount of VAT revenue. These businesses are also the ones that are most likely to be eligible for the SME exemption under the current VAT legislation.

## 3. Assessment of the measures for small businesses under the VAT Directive

### *Question 1: What is the current situation?*

#### VAT compliance costs for SMEs

Small businesses bear proportionally higher VAT compliance costs than large businesses since many of these costs are fixed rather than proportional to their turnover, while the revenue generated by them is very small. The study has estimated that the overall compliance costs for a small business (with turnover below EUR 100 000) under the standard VAT regime are approximately EUR 2 970 per year<sup>216</sup> (of which EUR 1 023 are advisory costs). These costs

<sup>216</sup> Overall compliance costs for small businesses (with turnover up to EUR 100 000) are estimated at EUR 68 billion per year. This figure includes businesses using the SME scheme, businesses opting for the standard VAT regime (while being eligible for the SME scheme) and businesses under the standard VAT regime (as not eligible for the SME scheme). See 2017 Deloitte study on SMEs, Volume I, p. 114.

stem from the complexity of the VAT rules (different rates, exemptions, different place of supply rules), the extensive number of VAT obligations and their frequency.

In addition, given the fragmentation of the VAT system<sup>217</sup>, compliance costs linked to intra-EU trade are much more significant for small and micro businesses, representing a real obstacle to cross-border trade<sup>218</sup>. In particular, national VAT regimes and administrative procedures can be quite complex in some Member States. Small businesses may often lack the knowledge required and have recourse to expensive tax advice.

#### Measures for SMEs under the VAT Directive

The VAT Directive sets out several provisions designed to alleviate the effects of SMEs having to deal with VAT, which are optional for both Member States and businesses. The special scheme for small enterprises ('SME scheme') provides, in particular, measures aimed at reducing the burden for SMEs of charging and collecting VAT, such as the flat-rate scheme (Article 281) and others eliminating this burden, such as the SME exemption and graduated relief (Articles 282-294). Member States may also relieve SMEs covered by the exemption or graduated relief from certain or all VAT obligations (Article 271). Other simplification measures outside the SME scheme are available to all businesses (e.g. simplified invoicing) or only to SMEs (e.g. cash accounting scheme).

The VAT Directive also provides Member States with significant flexibility to design their SME scheme at national level. As a result, the national schemes may differ considerably among Member States<sup>219</sup> (e.g. exemption thresholds and number of simplified VAT obligations combined with the exemption).

#### New trends in the economy

E-commerce and technological developments have created new opportunities for consumers and entrepreneurs (e.g. through collaborative economy platforms) as well as new forms of business that may significantly change the concept of 'economic activity', hence making the application of VAT rules particularly challenging.

Additionally, the increasing number of occasional traders resulting from these developments can be a burden for tax authorities and since compliance control costs are disproportionate compared to revenue collected there may be little benefit.

For SMEs, the current VAT system is not targeted to properly address these new trends and related issues.

---

<sup>217</sup> Since VAT is levied in the Member State of the customer and in accordance with that Member State's laws, different national VAT rules will apply and different tax authorities will be involved.

<sup>218</sup> The average cost for SMEs to account for VAT in another Member State is estimated to be EUR 4 100 annually per Member State they supply to. This compares to the average of EUR 8 000 for larger businesses. The estimates reflect lower activity levels for SMEs. See Deloitte Study on '*Modernising VAT for cross-border e-commerce*', Lot 1, p. 44.

<sup>219</sup> See Annexes 10 and 11 for an overview of the VAT obligations linked to the SME exemption and other simplified measures per Member State.

## **Question 2: How effective has the EU intervention been?**

The SME exemption provides a significant tax benefit for SMEs as it removes entirely the burden of collecting VAT related to domestic supplies. Additionally, the scheme lowers substantially the administrative burden for businesses applying the scheme, due to the fact that Member States often provide together with the exemption for simplified VAT obligations, according to Article 272(1)(d) of the VAT Directive.

However, the current SME exemption presents some weaknesses that make the scheme unable to fully address the need of reducing the burden of small businesses related to the application of normal VAT rules. In particular:

- simplified VAT obligations are optional for Member States (hence use and design is non-harmonised) and only applicable together with the exemption. This means that eligible small businesses opting out of the exemption (e.g. to be able to obtain input VAT deduction) cannot benefit from less burdensome obligations;
- the scheme is only applicable to established businesses (Article 283(1)(c) of the VAT Directive). Therefore cross-border supplies are not covered by the exemption. SMEs wishing to trade in other Member States are required to register and account for VAT in those Member States<sup>220</sup> and indeed are confronted with a more complex and costly legislative framework.

### Cost-benefit analysis for businesses

The inherent consequence of the exemption is that the business is not allowed to deduct input VAT (Article 289 of the VAT Directive). Therefore, opting for the exemption will depend on whether, despite the cost of non-deductible input VAT, the exempted SME is able to offer lower prices to its customers (competitive advantage). Although, the scheme is applicable to both B2C and B2B transactions<sup>221</sup>, the study confirmed that it is more beneficial where most of the SME' customers are final consumers or exempted businesses (with no right to deduct input VAT) and where the amount of input VAT is relatively lower than output VAT<sup>222</sup>.

Moreover, it results from the study that one of the main reasons (hence one of the main benefits) in opting for the scheme is due, despite the tax benefit, to the possibility for exempted SMEs to be discharged from all or some of the VAT obligations<sup>223</sup>. Therefore, the SME exemption has proved to be more effective where it is accompanied by a number of simplified VAT obligations (see Table 23).

---

<sup>220</sup> This is currently the case for B2C supplies of goods, where the distance sales threshold is reached (Article 34 of the VAT Directive) and B2C supplies of services other than 'electronic services' to which the simplified registration and payment system 'the mini One Stop Shop' (MOSS) is applicable.

<sup>221</sup> See Article 283 of the VAT Directive.

<sup>222</sup> In particular, it was observed that SMEs may prefer to charge VAT on their supplies and opt out of the scheme in order to enable their B2B customers to recover input VAT. See the 2017 Deloitte study on SMEs, Volume I, p. 80-82.

<sup>223</sup> While the obligations within the national schemes vary across Member States, in the majority of the cases SMEs applying the scheme do not have to file periodical VAT returns and issue VAT invoices. Additionally, about two thirds of Member States do not require the business covered by the SME scheme to register for VAT purposes, thus the exemption threshold may also be considered as VAT registration threshold.



## Threshold effect

Another drawback of the exemption is due to the fact that in most Member States once the exemption threshold is reached the business has to comply with the full set of VAT obligations all at once, losing both tax and administrative incentives. As a result of this, businesses limit their sales to remain below the threshold so as to avoid the sudden change in compliance costs. Such adverse behaviour appears to be relatively permanent, implying a decrease in SMEs' growth in the medium-long term<sup>224</sup>.

### **Question 3: How efficient has the EU intervention been?**

#### Impacts on compliance costs for SMEs

Overall, it was estimated that **the SME exemption reduces compliance costs for small businesses by approximately 60%** compared to businesses using the standard VAT regime<sup>225</sup> (saving on average around EUR 1 500 per business per year). However, the reduction of the compliance burden for SMEs applying the scheme varies substantially across Member States, depending on the simplified VAT obligations attached to the scheme. As shown in the table below, compliance costs for businesses within the scheme range from zero, as in the case of Estonia, Romania and the UK (where businesses are released from all VAT-related obligations) to EUR 1 381 per business annually, as in the case of Italy (where businesses are still required to register for VAT and issue invoices).

It is important to note that the SME exemption can be linked to other additional simplification measures not VAT-related which can further support the business' decision to opt for the scheme<sup>226</sup>.

**Table 23: Compliance costs for SMEs within and outside the SME exemption in selected Member States**

Member State	Within the SME exemption		Outside of the SME exemption	
	Relevant IOs	Overall costs (annual basis)	Relevant IOs	Overall costs (annual basis)
<b>Estonia</b>	No VAT-related obligations	No VAT-related compliance costs	<ul style="list-style-type: none"><li>• VAT registration</li><li>• Invoicing (re domestic)</li><li>• VAT declarations/returns</li><li>• VAT payment (domestic)</li><li>• Bookkeeping</li></ul>	<b>EUR 872</b>  (of which advisory fees: EUR 183)
<b>France</b>	<ul style="list-style-type: none"><li>• Applying for exemption</li><li>• Bookkeeping</li></ul>	<b>EUR 960</b>	<ul style="list-style-type: none"><li>• VAT registration</li><li>• VAT input</li><li>• Invoicing (re domestic)</li><li>• VAT declarations/returns</li></ul>	<b>EUR 1 981</b>  (of which advisory fees: EUR 265)

<sup>224</sup> See the 2017 Deloitte study on SMEs, Volume I, section 5.4.3.

<sup>225</sup> The assessment of the compliance costs under the SME exemption was carried out for five Member States (Estonia, France, Italy, Romania and the UK).

<sup>226</sup> In Italy, for instance, the SME exemption is combined with a substitute tax of 15% or 5% for both income and regional taxation.

Member State	Within the SME exemption		Outside of the SME exemption	
	Relevant IOs	Overall costs (annual basis)	Relevant IOs	Overall costs (annual basis)
			<ul style="list-style-type: none"> <li>VAT payment (domestic)</li> <li>Bookkeeping</li> </ul>	
<b>Italy</b>	<ul style="list-style-type: none"> <li>VAT registration</li> <li>Invoicing (re domestic)</li> <li>VAT return ('Unico', annual statement)</li> </ul>	<b>EUR 1 371</b> (of which advisory fees: EUR 500)	<ul style="list-style-type: none"> <li>VAT registration</li> <li>Invoicing (re domestic)</li> <li>VAT declarations/returns</li> <li>VAT payment (domestic)</li> <li>Bookkeeping</li> </ul>	<b>EUR 2 907</b> (of which advisory fees: EUR 1 015)
<b>Romania</b>	No VAT-related obligations	No VAT-related compliance costs	<ul style="list-style-type: none"> <li>VAT registration</li> <li>Invoicing (re domestic)</li> <li>VAT declarations/returns</li> <li>VAT payment (domestic)</li> <li>Bookkeeping</li> </ul>	<b>EUR 2 500</b> (of which are advisory fees: EUR 2 215)
<b>UK</b>	No VAT-related obligations	No VAT-related compliance costs	<ul style="list-style-type: none"> <li>VAT registration</li> <li>Invoicing (re domestic)</li> <li>VAT declarations/returns</li> <li>VAT payment (domestic)</li> <li>Bookkeeping</li> </ul>	<b>EUR 2 492</b> (of which are advisory fees: EUR 1 100)
<b>EU average</b>		<b>EUR 550</b> of which hidden costs for monitoring the threshold are EUR 193		<b>EUR 2 964</b> of which advisory fees are EUR 1 023

Source: 2017 Deloitte SME study

### Impacts on Member States

The SME exemption does generally reduce also administrative costs of tax collection and control for tax authorities, as in most of the Member States it lowers the number of VAT registered taxable persons<sup>227</sup>.

However, the scheme leads to loss of VAT revenues for Member States which is to a certain extent intentional for them (cost-benefit analysis). In this regard, it should be noted that the proportion of small businesses exempted from VAT is estimated to be around 27% of all EU businesses, representing 0.3% of the total turnover generated in the EU<sup>228</sup>. Consequently the foregone VAT revenue for tax authorities is estimated to be negligible (EUR 3.8 billion or 0.4% of net VAT revenues collected in the EU<sup>229</sup>).

<sup>227</sup> Tax authorities interviewed could not provide any specific data to quantify such reduction.

<sup>228</sup> Businesses covered by the SME exemption are approximately 11 million in the EU. See 2017 Deloitte, Volume II, tables 29, 30 and 75.

<sup>229</sup> See 2017 Deloitte, Volume I, p. 120.

## Cross-border implications of the SME exemption

The territorial application of the exemption creates distortions in the internal market due to the unequal treatment between suppliers from other Member States that do not have access to the SME exemption in the Member State of destination and suppliers established in that Member State that can benefit from the exemption.

The territorial scope of the scheme may also discourage domestic businesses from trading in other Member States and fully seizing the opportunities of the Single Market<sup>230</sup>.

Little evidence is available, however, on the cross-border trading behaviours of SMEs within and outside of the exemption. Estimates from the 2017 Deloitte Study indicate that on average 30% of businesses in the EU sell to other EU Member States. While the proportion of small businesses exempted under the current SME exemption (likely those with a turnover of less than EUR 50 000) which are involved in intra-EU trade is about 12%<sup>231</sup>.

It is important to note that also dissimilarities in national VAT regimes (e.g. dissimilarities in VAT administrative procedures and rates) affect negatively intra-EU trade, particularly bilateral trade flows<sup>232</sup>.

### ***Question 4: How relevant is the EU intervention?***

SMEs are considered the engine of the EU economy, representing 98% of all EU businesses and contributing to over 65% of employment in the private sector. Because of their size, small businesses are much better at identifying and embracing new trends in the industry and, therefore, driving innovation within their respective sectors. Small businesses, particularly micro-businesses, can also be much more adaptable to change than larger and more complex organisations. Hence, their development is fundamental to ensuring economic growth, innovation, job creation, and social integration in the EU. Yet many obstacles preclude SMEs from seizing the full potential of the Single Market. For instance, diverse and complex VAT rules across the EU can result in a high compliance burden on SMEs, particularly when trading with other Member States. This does not only hamper their growth but may even prevent them from engaging in cross-border trade and reap the benefits of the Single Market. As stated above, despite representing a significant part of the economic activity in the EU, small businesses only generate 15% of the total EU turnover compared to large companies which contribute over 75%.

With the Small Business Act for Europe, the EU put SMEs at the centre of its policy actions and adopted two key principles to address their needs: designing rules according to ‘Think Small First’ and helping SMEs to benefit more from the opportunities offered by the Single Market.

### ***Question 5: How coherent is the EU intervention internally and with other (EU) actions?***

The modernisation of the VAT system, of which the special scheme for small businesses constitutes an integral part, is an ongoing long-term process started in 2010<sup>233</sup>. The guiding

---

<sup>230</sup> It was estimated that if the VAT compliance costs associated with intra-EU trade were equivalent to 1% of firms’ sales, eliminating them would increase intra-EU trade by 4.3%, GDP by 0.4% and consumption by 0.3%. See IFS et al., 2011, A retrospective evaluation of elements of the EU VAT system, p. 23.

<sup>231</sup> See the 2017 Deloitte study on SMEs, Volume I, p. 43.

<sup>232</sup> It was estimated that a 10% reduction in the dissimilarity of general VAT obligations would increase intra-EU trade by 3.7%, GDP by 0.4% and consumption by 0.3%. See IFS et al., 2011, A retrospective evaluation of elements of the EU VAT system, p. 23.

principles of this work are, first, that businesses trading across the EU and those trading only domestically must be treated equally and, secondly, that the VAT compliance costs related to intra-EU trade must be reduced. The creation of a simple, modern and fraud-proof VAT system is indeed one of the fiscal priorities set out by the Commission for 2017 (Annual Growth Survey 2017<sup>234</sup>) which should contribute to deepening the Single Market.

An EU intervention in the VAT area aimed at reducing the compliance burden on small businesses would be consistent with the Single Market Strategy (SMS)<sup>235</sup>, which recognises the complexity of VAT rules for SMEs and identify some initiatives to assist small businesses accessing the Single Market. This intervention would also be consistent with the objectives under the REFIT<sup>236</sup> programme to make the EU law simple and less costly, mainly for small businesses.

The objective of reducing compliance burdens for SMEs is also highlighted in the EU's growth strategy for the coming decade (Europe 2020 – A strategy for smart, sustainable and inclusive growth<sup>237</sup>).

### **Question 6: What is the EU added value of the intervention?**

The above analysis confirmed that the current VAT rules for small businesses suffer from several drawbacks. In particular, the SME exemption, based largely on when Member States joined the EU, does not reflect the Single Market perspective and the move to a definitive system based on the destination principle: the scheme is targeted mostly at businesses trading domestically and in the B2C context.

The assessment identified some areas for improvements of VAT rules for small businesses that require EU intervention<sup>238</sup>. The amendments to the VAT Directive should bring, in particular, the following benefits:

- **More level playing field for SMEs.** The existing distortions should be addressed at two levels: (1) between small businesses under the SME exemption and those that do not make use of the exemption; (2) between small businesses that trade only domestically and those that trade cross-border.
- **Greater effectiveness in reducing VAT compliance costs for SMEs.** Simplified VAT obligations should be made available for all eligible SMEs and not only to those covered by the SME exemption (this would in particular address the problem of SMEs trading mostly B2B). Furthermore, the regulatory framework should provide an alignment between different national regimes making use of best practises (e.g. common set of simplified requirements).

---

<sup>233</sup> Work on the future of VAT started with the launch of the 2010 Green Paper followed by the 2011 Communication.

<sup>234</sup> [https://ec.europa.eu/info/publications/2017-european-semester-annual-growth-survey\\_en](https://ec.europa.eu/info/publications/2017-european-semester-annual-growth-survey_en)

<sup>235</sup> [http://ec.europa.eu/growth/single-market/strategy\\_en](http://ec.europa.eu/growth/single-market/strategy_en)

<sup>236</sup> Regulatory Fitness and Performance programme: [http://ec.europa.eu/info/law/law\\_makingprocess/overview-law-making-process/evaluating-and-improving-existing-laws/reducing-burdens-and\\_simplifying-law/refit-making-eu-law-simpler-and-less-costly\\_en](http://ec.europa.eu/info/law/law_makingprocess/overview-law-making-process/evaluating-and-improving-existing-laws/reducing-burdens-and_simplifying-law/refit-making-eu-law-simpler-and-less-costly_en)

<sup>237</sup> <http://eur-lex.europa.eu/LexUriServ/LexUriServ.do?uri=COM:2010:2020:FIN:EN:PDF>

<sup>238</sup> The EU has exclusive competence in the field of indirect taxation to the extent that such intervention is necessary to ensure the establishment and the functioning of the internal market and to avoid distortion of competition, under Article 113 of the TFEU.

- **Encourage small business growth.** It results from the analysis that compliance costs may also affect SMEs' growth. A more effective intervention to reduce these costs will improve SMEs' competitiveness overall, hence boosting their domestic and cross-border activity. Moreover, the VAT system may provide specific provisions to support fast-growing SMEs (e.g. smooth transition to full taxation and standard VAT regime).

#### 4. Conclusions

Overall, the evaluation has confirmed that, given the complexity of the current VAT system and the high compliance costs faced by small businesses when dealing with VAT, the existence of a special scheme for SMEs in the VAT Directive is still amply justified. Complying with VAT rules is extremely complex and costly, particularly when SMEs engage in intra-EU trade.

Although the SME scheme has proved to be effective in reducing SMEs' burden related to the application of normal VAT rules, it offers a limited and fragmented response. Namely, the effectiveness of the scheme varies considerably from one Member State to another depending, in particular, on the number of simplified VAT obligations combined with the exemption and the type of economic activity carried out by the SMEs. Moreover, the scheme creates distortive effects on competition at both domestic and cross-border level, as it does not take into account the Single Market perspective.

It should be noted that with the evolution of the VAT system towards taxation at destination, compliance costs related to intra-EU trade are likely to increase<sup>239</sup>. The heavy burden for small businesses will therefore increase if there is no action at EU level to simplify VAT obligations. Failure to act will consequently lead to more distortions in the Single Market and negative effects for SMEs' growth.

---

<sup>239</sup> Once the definitive regime will enter into force, the supplier will have to charge and account for VAT in the Member State of destination. At present, intra-EU B2B supplies of goods are exempted under Article 138 of the VAT Directive.

## ANNEX 9: SME EXEMPTION THRESHOLDS IN THE EU (APRIL 2017)

Member State <sup>240</sup>	Exemption for small enterprises <sup>241</sup>		Derogation granted by <sup>242</sup>	Date of expiry
	In euro <sup>243</sup>	National currency		
Belgium	25 000		<a href="#">Council Implementing Decision 2013/53/EU</a>	31/12/2018
Bulgaria	25 565	BGN 50 000		
Czech Republic	37 008	CZK 1 000 000		
Denmark	6 726	DKK 50 000		
Germany	17 500			
Estonia <sup>244</sup>	16 000			
Ireland	75 000 37 500			
Greece	10 000			
Spain	None			
France	82 800 42 900 33 100			
Croatia	30 864	HRK 230 000	<a href="#">Council Implementing Decision (EU) 2017/1768</a>	31/12/2020
Italy	25 000 30 000 40 000 45 000 50 000		<a href="#">Council Implementing Decision 2013/678/EU</a>	31/12/2019
Cyprus	15 600			
Latvia	50 000		<a href="#">Council Implementing Decision 2014/796/EU</a>	31/12/2017
Lithuania	45 000		<a href="#">Council Implementing Decision 2011/335/EU</a>	31/12/2020 <sup>245</sup>
Luxembourg	30 000		<a href="#">Council Implementing Decision 2013/677/EU</a>	31/12/2019

<sup>240</sup> Some Member States apply different threshold based on factors such as the nature of the supply (goods/services) or the level of added value (high/low).

<sup>241</sup> This is based on Articles 284 to 287 of the VAT Directive. This scheme is, according to Article 283(1)(c) of the VAT Directive, reserved for taxable persons established within the territory of the Member State in which the VAT is due.

<sup>242</sup> A total of 9 Member States are currently relying on derogations.

<sup>243</sup> For Member States not using the euro, the thresholds in euro has been calculated based on the foreign exchange reference rates as published by the European Central Bank for 21 February 2017.

<sup>244</sup> As of 1/1/2018 the exemption threshold will be EUR 40 000 – see Council Implementing Decision 2017/563/EU. The expiry date of the derogation is 31/12/2020.

<sup>245</sup> See Council Implementing Decision 2017/1853/EU amending Implementing Decision 2011/335/EU.

Member State <sup>240</sup>	Exemption for small enterprises <sup>241</sup>		Derogation granted by <sup>242</sup>	Date of expiry
	In euro <sup>243</sup>	National currency		
Hungary	26 067	HUF 8 000 000		
Malta	35 000 24 000 14 000			
Netherlands	None	None		
Austria	30 000			
Poland	46 442	PLN 200 000	<a href="#">Council Decision 2009/790/EC</a>	31/12/2018
Portugal	12 500 10 000			
Romania <sup>246</sup>	48 725	RON 220 000	<a href="#">Council Implementing Decision 2012/181/EU</a>	31/12/2017
Slovenia	50 000		<a href="#">Council Implementing Decision 2013/54/EU</a>	31/12/2018
Slovakia	49 790			
Finland	10 000			
Sweden	3 168	SEK 30 000		
United Kingdom	97 808	GBP 83 000		

Source: Commission services

<sup>246</sup> Threshold expressed in national currency calculated from the EUR values at the exchange rate on the date of accession, i.e. 1.1.2007. As of 1/1/2018 the exemption threshold will be EUR 88 500 – see Council Implementing Decision 2017/1855/EU. The expiry date of the derogation is 31/12/2020.

**ANNEX 10: SPECIAL VAT SME MEASURES APPLIED IN MEMBER STATES**

Member State	SME exemption	SME graduated relief	SME flat rate scheme	Cash accounting scheme
Belgium	✓	✗	✓	✗
Bulgaria	✓	✗	✗	✓
Czech Republic	✓	✗	✗	✗
Denmark	✓	✗	✗	✗
Germany	✓	✗	✓	✓
Estonia	✓	✗	✗	✓
Ireland	✓	✗	✗	✓
Greece	✓	✗	✓	✓
Spain	✗	✓	✓	✓
France	✓	✗	✗	✗
Croatia	✓	✗	✗	✓
Italy	✓	✗	✗	✓
Cyprus	✓	✗	✓	✓
Latvia	✓	✗	✗	✓
Lithuania	✓	✗	✗	✓
Luxembourg	✓	✗	✗	✓
Hungary	✓	✗	✗	✓
Malta	✓	✗	✓	✓
Netherlands	✗	✓	✗	✓
Austria	✓	✗	✗	✓
Poland	✓	✗	✓	✓



Member State	SME exemption	SME graduated relief	SME flat rate scheme	Cash accounting scheme
Portugal	✓	✗	✗	✓
Romania	✓	✗	✗	✓
Slovenia	✓	✗	✗	✓
Slovakia	✓	✗	✗	✓
Finland	✓	✓	✗	✓ <sup>247</sup>
Sweden	✓ <sup>248</sup>	✗	✗	✓
UK	✓	✗	✓	✓
<b>Total</b>	<b>26</b>	<b>3</b>	<b>8</b>	<b>24</b>

Source: Commission services on the basis of 2017 Deloitte SME study (Deloitte Tax Network Survey)

<sup>247</sup> Finland introduced a cash accounting scheme from 1 January 2017: [https://www.vero.fi/en-US/Tax\\_Administration/Changes2017/Legislative\\_changes\\_affecting\\_taxes\\_in\\_2\(40836\)](https://www.vero.fi/en-US/Tax_Administration/Changes2017/Legislative_changes_affecting_taxes_in_2(40836)).

<sup>248</sup> Sweden introduced a SME exemption from 1 January 2017: <https://data.riksdagen.se/fil/BABBC8C1-C310-432D-9C10-08801D44891F>.

**ANNEX 11: VAT OBLIGATIONS LINKED TO THE SME EXEMPTION PER MEMBER STATE**

Member State	Exemption from charging VAT on supplies	Requirement to register for VAT purposes	Requirement to register for other purposes <sup>249</sup>	Obligation to submit periodical VAT returns	Simplified accounting obligations	Obligation to issue VAT invoices
Belgium	✓	✓	✓	✗	✓	✓
Bulgaria	✓	✗	✓	✗	✗	✗
Czech Republic	✓	✗	✗	✗	✗	✗
Denmark	✓	✗	✓	✗	✓	✗
Germany	✓	✓	✓	✗	✓	✗
Estonia	✓	✗	✓	✗	✓	✗
Ireland	✓	✗	✓	✗	✓	✗
Greece	✓	✓	✓	✗	✗	✓
Spain	no SME exemption, but SME graduated relief, flat rate scheme and cash accounting to tackle the tax and compliance burden					
France	✓	✗	✓	✗	✓	✓
Croatia	✓	✗	✓	✗	✗	✓
Italy	✓	✓	✓	✗	✓	✓
Cyprus	✓	✗	✓	✗	✗	✗
Latvia	✓	✗	✗	✗	✓	✗
Lithuania	✓	✗	✓	✗	✗	✗
Luxembourg	✓	✓	✓	✗	✓	✓
Hungary	✓	✓	✓	✗	✗	✓
Malta	✓	✓	✓	✗ <sup>250</sup>	✓	✓

<sup>249</sup> Such as for commercial or other tax purposes (e.g. corporate or income tax).

<sup>250</sup> Malta released from obligation to submit periodical VAT returns if turnover below EUR 7 000.

Member State	Exemption from charging VAT on supplies	Requirement to register for VAT purposes	Requirement to register for other purposes <sup>249</sup>	Obligation to submit periodical VAT returns	Simplified accounting obligations	Obligation to issue VAT invoices
Netherlands	no SME exemption, but SME graduated relief to reduce tax burden					
Austria	✓	✗	✓	✗	✓	✗
Poland	✓	✗	✓	✗ <sup>251</sup>	✓	✗
Portugal	✓	✓	✓	✗	✓	✓
Romania	✓	✗	✓	✗	✗	✗
Slovenia	✓	✗	✓	✗	✓	✗
Slovakia	✓	✗	✓	✗	✗	✗
Finland	✓	✗	✓	✗	✓	✗
Sweden	✓	✗	✓	✗	✓	✗
UK	✓	✗	✓	✗	✓	✗

Source: Commission services on the basis of 2017 Deloitte SME study (Deloitte Tax Network Survey)

<sup>251</sup> Poland released from obligation to submit periodical VAT returns.

## ANNEX 12: ENTERPRISE EUROPE NETWORK – SME FEEDBACK DATABASE

The Enterprise Europe Network<sup>252</sup> (EEN) is a project managed by the European Commission (DG GROW) which helps businesses innovate and grow on an international scale, being the world's largest support network for SMEs with international ambitions. The network is made of 600 partners or intermediary organisations (Chambers of Commerce and Industry, Innovation agencies, regional development agencies, Technology Transfer departments of Universities and other SME support organisations) in all EU Member States and more than 30 non-EU countries.

The EEN provides assistance to the European Commission in getting the opinion of SMEs on European legislation and initiatives, among others, through the 'SME feedback database'. This database is a register of practical problems with EU legislation experienced by SMEs, as reported by EEN partners. Since 2006, more than 8 000 contributions have been submitted. VAT-related cases represent 10% of this overall database and constitute one of the main problems encountered by SMEs seeking advice from the EEN.

Find below extracts of some of the problems which are relevant for the purposes of this proposal, as indicated by EEN members in the SME feedback database<sup>253</sup>. Although they are not representative and should be treated as anecdotal, they are real-life examples which illustrate the VAT compliance burdens faced by SMEs, notably in relation to cross-border trade.

**Table 24: Examples from the SME feedback database**

Year of the contribution	EEN member contribution (extracts)
2014	A local start-up company contacted our offices to get information on e-business of food products in the EU. They are planning to sell typical Italian food (except wine) via web, so they needed to be assisted on the main aspects before launching the web. They were in particular interested in fiscal aspects. They tried to find info on their own but they had difficulties in finding official sources and clear explanations on the functioning of the intra-EU vat for e-business. After losing much time, they addressed to us. We therefore explained the VAT functioning, in case of selling to EU private consumers. In particular the main aspect concerns the national threshold of the sales. If it is exceeded, they have to open a fiscal number in the other EU country. This means additional time and also costs for the local fiscal mandate.
2014	A self-employed translator established in one Member State is exempt from VAT there, and he has potential clients in other Member States. He wants to obtain a VAT identification number in order to sell to clients in other Member States (where he has to declare VAT), but he finds out from his tax administration that he will be denied the possibility to profit from the exemption in his Member State, as a consequence of having obtained a VAT number <sup>254</sup> .
2012	For obtaining the VAT identification number in another Member State, the criteria often change across the EU and the information is in national languages. The information is neither clear nor harmonised at EU level <sup>255</sup> .
2011	A photographer based in Austria intends to take pictures in Italy during public events. Right after taking the pictures he is going to try and sell these pictures to the participants and guests on the event. However, as this sales activity is taken out I Italy and therefore subject to Italian VAT, the foreign photographer is required to register for taxing purposes in Italy.

<sup>252</sup> <http://een.ec.europa.eu/about/about>

<sup>253</sup> This database is not publicly available, and this is why only some fragments of the contributions received by EEN members are reproduced in an anonymous way.

<sup>254</sup> Original contribution in French (our translation).

<sup>255</sup> *Ibid.*

2011	Our (self-employed) client wanted to supply services connected with immovable property to a client in Poland. This kind of services is taxable in the country where the property is located, in this case in Poland. This means that our client would have to register with the Polish tax authorities. In Germany our client is classified as "small enterprise" which means that he is not obliged to invoice VAT. As he opted for this regime he would prefer to avoid VAT registration in Poland, as well. However this is not possible.
2010	Our client has set up a website where he sells goods and wine. Most of customers are from Member States other than the one where he is established (France). Registering in every Member State where he sells wine requires lots of time and sometimes the need to appoint a fiscal representative in the Member State of destination. This is a handicap for this very young enterprise that wishes to develop in the Single Market <sup>256</sup> .
2010	An Austrian-based retailer for food specialties was invited by an Italian community to sell his food specialties during a fair ground to the visitors. The selling activities would be for 3 days during a weekend. As the turnover of this selling activity is carried out at the Italian taxing territory it is subject to Italian VAT. As a result the company needs to be registered for taxing purposes at the Italian VAT office.
2010	EC Companies that are not based in the UK and which do some assembling and installation work in the territory of the UK, are obliged to register for taxing purposes in UK, in the case that these foreign companies do exceed a certain annual threshold. This threshold is at about EUR 90 000 per annum, so will be met easily even for medium-sized orders. Also in the case the contract is made with a company already tax registered in the UK (and not with an individual) the taxing registration requirement is in force and has to be met. Even though a representative has not to be appointed by law, due to unknown and unfamiliar procedures, deadlines and forms, SMEs cannot refrain from appointing a representative at sometimes high charges in relation to the order.
2007	The complaining company runs a bookstore in Austria and due to an invitation by a publisher based in Denmark, the Austrian bookshop intends to display books on a book fair in Denmark. To make some profits to finance to presentation costs in Denmark, the company also wants to offer some books for sale. The problem is that the place of sale is located in Denmark, so sales will be taxable in Denmark and a taxing registration is required. But as the expected turnover during the 5-days bookfair may be about EUR 1 000,- only, the costs arising from registration (by using the help of an export) will exceed the expected income by far.
2007	Many small and medium sized companies face high expenses when trying to do business in other Member States. In the current case an Austrian based stove builder got an order from an individual client based in Italy. The place of order was in Italy as well and as the client was an individual, the company was forced to make a tax registration in Italy to satisfy Italian tax rules and to charge Italian tax to the individual client. As the Austrian stove builder was facing linguistic barriers along with unknown tax rules, he was forced to name a tax representative in Italy. Unfortunately the income of the Italian order was almost as high as the costs for the Italian tax representative.
2007	A French micro enterprise has been selling goods in several fairs in Belgium. It is required to declare and pay VAT in Belgium for such sales, while it is exempted from VAT in France <sup>257</sup> .

Source: Commission services, based on the SME feedback database.

<sup>256</sup> *Ibid.*

<sup>257</sup> *Ibid.*